



This owner's manual should be considered a permanent part of the vehicle and should remain with the vehicle when it is sold.

This owner's manual covers all versions. Therefore, you may find descriptions of equipment and features that are not on your particular vehicle.

The information and specifications included in this publication were in effect at the time of approval for printing. Honda Motor Co., Ltd. reserves the right, however, to discontinue or change specifications or design at any time without notice and without incurring any obligation whatsoever.

Although this manual is applicable to both right-hand and left-hand drive models, the illustrations contained in this manual mainly refer to the left-hand drive models.





Introduction



Congratulations! Your selection was a wise investment. It will give you years of driving pleasure.

One of the best ways to enhance the enjoyment of your new vehicle is to read this manual. In it, you will learn how to operate its driving controls and convenience items. Afterwards, keep this owner's manual in your vehicle so you can refer to it at any time.

Several other booklets explain the warranties that protect your new vehicle. Read the Service Book/warranty booklet thoroughly so you understand the coverages and are aware of your rights and responsibilities.

Maintaining your vehicle according to the schedules given in this manual or the separate service information booklet helps to keep your driving trouble-free while it preserves your investment. When your vehicle needs maintenance, keep in mind that your dealer's staff is specially trained in servicing the many systems unique to your vehicle. Your dealer is dedicated to your satisfaction and will be pleased to answer any questions and concerns.

Best wishes and happy motoring.

Symbols   on labels attached to your vehicle are to remind you to read this owner's manual for proper and safe operation of your vehicle.

As you read this manual, you will find information that is preceded by a **NOTICE** symbol. This information is intended to help you avoid damage to your vehicle, other property, or the environment.

(On German type)

1. Mounting the front licence plate:
Mount the front licence plate to the provided holder taking care that the upper edge of the licence plate does not project above the upper surface of the bumper.
2. Mounting the rear licence plate:
Mount the rear licence plate to the back of the vehicle so that its lower edge is flush with the lower end of the surface provided for mounting.





A Few Words About Safety

Your safety, and the safety of others, is very important. And operating this vehicle safely is an important responsibility.

To help you make informed decisions about safety, we have provided operating procedures and other information on labels and in this manual. This information alerts you to potential hazards that could hurt you or others.

Of course, it is not practical or possible to warn you about all the hazards associated with operating or maintaining your vehicle. You must use your own good judgement.

You will find this important safety information in a variety of forms, including:

- **Safety Labels** – on the vehicle.
- **Safety Messages** – preceded by a safety alert symbol  and one of three signal words: **DANGER**, **WARNING**, or **CAUTION**.
These signal words mean:

 **DANGER**

You WILL be KILLED or SERIOUSLY HURT if you don't follow instructions.

 **WARNING**

You CAN be KILLED or SERIOUSLY HURT if you don't follow instructions.

 **CAUTION**

You CAN be HURT if you don't follow instructions.

- **Safety Headings** – such as Important Safety Reminders or Important Safety Precautions.
- **Safety Section** – such as Driver and Passenger Safety.
- **Instructions** – how to use this vehicle correctly and safely.

This entire book is filled with important safety information – please read it carefully.





Contents

Turn to the beginning of each section for a complete list of subjects.

Your Vehicle at a Glance..... 2

Driver and Passenger Safety..... 7

Important information about the proper use and care of your vehicle's seat belts, an overview of the supplemental restraint system, and valuable information on how to protect children with child restraints.

Instruments and Controls 69

Explains the purpose of each instrument panel indicator and gauge, and how to use the controls on the dashboard and steering column.

Features..... 139

How to operate the climate control system, the audio system, and other convenience features.

Before Driving 183

What fuel to use, how to break-in your new vehicle, and how to load luggage and other cargo.

Driving..... 199

The proper way to start the engine, shift the transmission, and park; plus what you need to know if you're planning to tow a trailer.

Maintenance 227

The maintenance schedule shows you when you need to take your vehicle to the dealer. There is also a list of things to check and instructions on how to check them.

Appearance Care..... 287

Tips on cleaning and protecting your vehicle.

Taking Care of the

Unexpected 295

This section covers several problems motorists sometimes experience, and details how to handle them.

Technical Information..... 327

ID numbers, dimensions, capacities, and technical information.

Index 341





Your Vehicle at a Glance

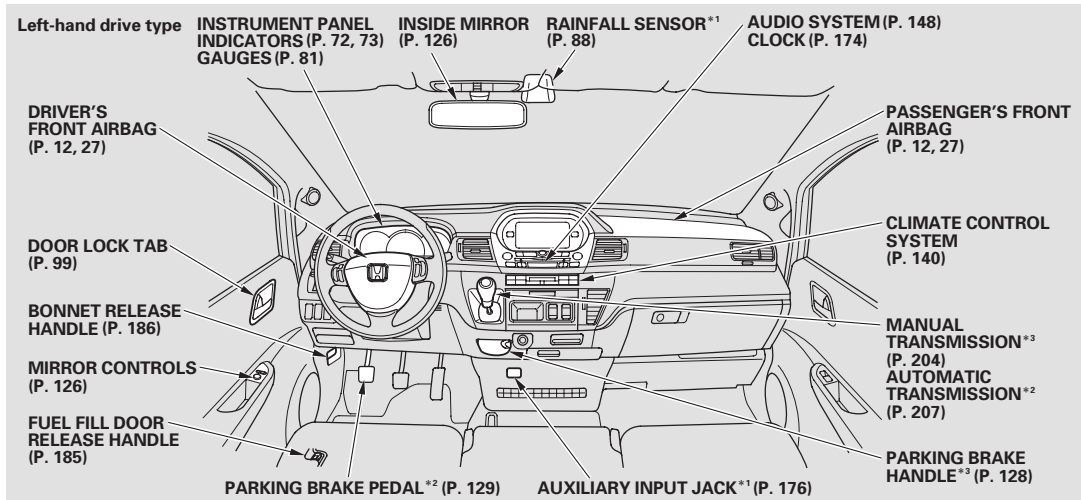

- * 1 : For some types
- * 2 : For automatic transmission models only
- * 3 : For manual transmission models only





Your Vehicle at a Glance

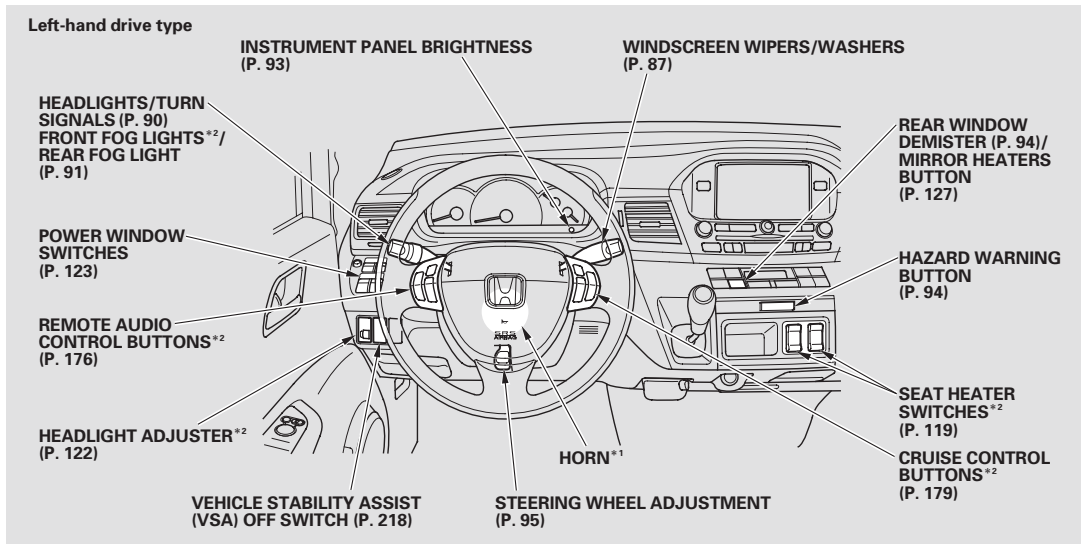

- * 1 : To use the horn, press the centre pad of the steering wheel.
- * 2 : For some types





Your Vehicle at a Glance

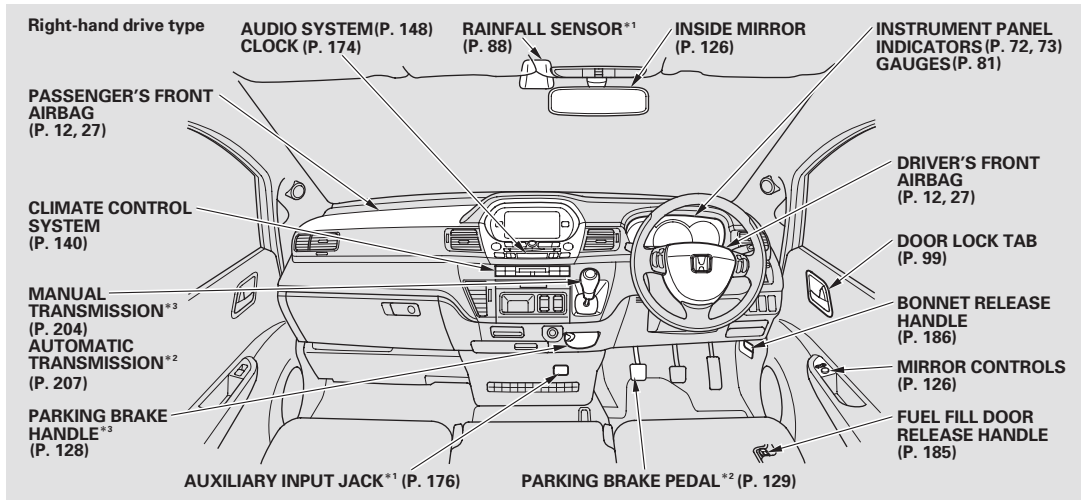

- * 1 : For some types
- * 2 : For automatic transmission models only
- * 3 : For manual transmission models only





Your Vehicle at a Glance

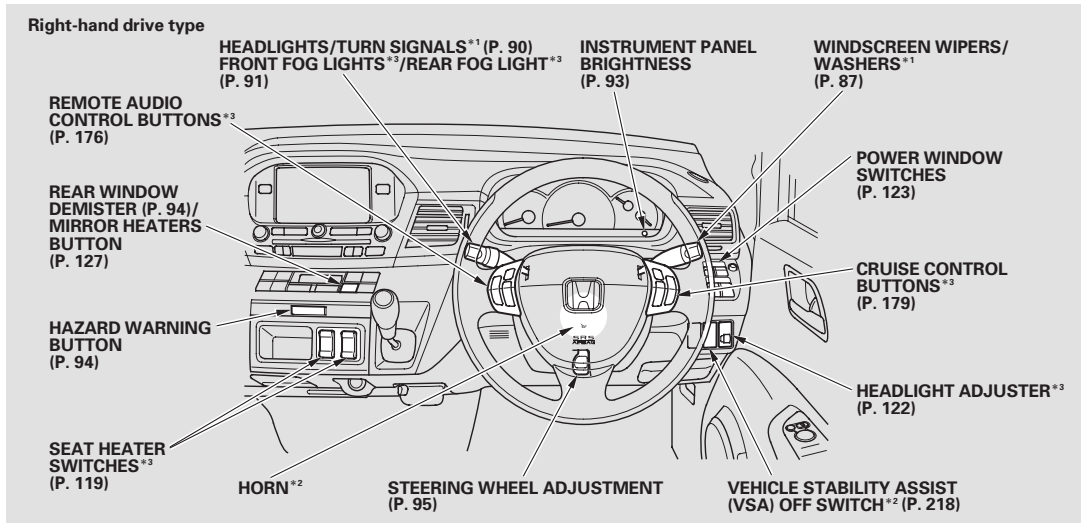

- * 1 : Except for European models, these switches change locations with each other.
- * 2 : To use the horn, press the centre pad of the steering wheel.
- * 3 : For some types





06/10/30 16:42:51 32SJD620_009





Driver and Passenger Safety

This section gives you important information about how to protect yourself and your passengers. It shows you how to use seat belts. It explains how your airbags work. And it tells you how to properly restrain infants and children in your vehicle.

Important Safety Precautions	8	Lap/Shoulder Belt.....	21	If You Must Drive with Several Children	36
Your Vehicle's Safety Features.....	9	Automatic Seat Belt Tensioners.....	23	If a Child Requires Close Attention	37
Seat Belts	10	Seat Belt Maintenance	23	Additional Safety Precautions....	37
Airbags.....	12	Additional Information About Your Airbags	26	Protecting Infants and Small Children	39
Protecting Adults and Teens.....	14	Airbag System Components.....	26	Protecting Infants.....	39
1. Close the Doors	14	How Your Front Airbags Work.....	27	Protecting Small Children	41
2. Adjust the Front Seats	14	How Your Side Airbags Work....	28	Selecting a Child Restraint System.....	43
3. Adjust the Seat-Backs	15	How Your Side Curtain Airbags Work	29	Installing a Child Restraint System.....	45
4. Adjust the Head Restraints	16	How the SRS Indicator Works ...	30	Child Restraint System for EU Countries	46
5. Fasten and Position the Seat Belts	17	Airbag Service.....	30	With the Lower Anchorages	47
6. Maintain a Proper Sitting Position	18	Additional Safety Precautions...	31	With a Lap/Shoulder Belt	52
Advice for Pregnant Women.....	19	Protecting Children – General Guidelines.....	32	With a Tether	57
Additional Safety Precautions....	20	All Children Must Be Restrained	32	Protecting Larger Children	60
Additional Information About Your Seat Belts.....	21	All Children Should Sit in a Back Seat	33	Checking Seat Belt Fit	61
Seat Belt System Components...	21	The Passenger's Front Airbag Poses Serious Risks.....	33	Using a Booster Seat	61
		The Side Airbag Poses Serious Risks.....	36	When Can a Larger Child Sit in Front.....	63
				Additional Safety Precautions....	64
				Carbon Monoxide Hazard	65
				Safety Labels	66





Important Safety Precautions

You'll find many safety recommendations throughout this section, and throughout this manual. The recommendations on this page are the ones we consider to be the most important.

Always Wear Your Seat Belt

A seat belt is your best protection in all types of collisions. Airbags are designed to supplement seat belts, not replace them. So even though your vehicle is equipped with airbags, make sure you and your passengers always wear your seat belts, and wear them properly (see page 17).

Restrain All Children

Children age 12 and under should ride properly restrained in the back seat or the front centre seat. However we recommend positioning children in the back to avoid possible distraction to the driver. Infants and small children should be restrained in a child restraint system. Larger

children should use a booster seat and a lap/shoulder belt until they can use the belt properly without a booster seat (see pages 32 – 64).

Be Aware of Airbag Hazards

While airbags can save lives, they can cause serious or fatal injuries to occupants who sit too close to them, or are not properly restrained. Infants, young children, and short adults are at the greatest risk. Be sure to follow all instructions and warnings in this manual.

Don't Drink and Drive

Alcohol and driving don't mix. Even one drink can reduce your ability to respond to changing conditions, and your reaction time gets worse with every additional drink. So don't drink and drive, and don't let your friends drink and drive, either.

Control Your Speed

Excessive speed is a major factor in crash injuries and deaths. Generally, the higher the speed, the greater the risk, but serious injuries can also occur at lower speeds. Never drive faster than is safe for current conditions, regardless of the maximum speed posted.

Keep Your Vehicle in Safe Condition

Having a tyre blowout or a mechanical failure can be extremely hazardous. To reduce the possibility of such problems, check your tyre pressures and condition frequently, and perform all regularly scheduled maintenance (see page 229 , and for EU countries and New Zealand, see the Service Book/separate service information booklet that came with your vehicle).





Your Vehicle's Safety Features

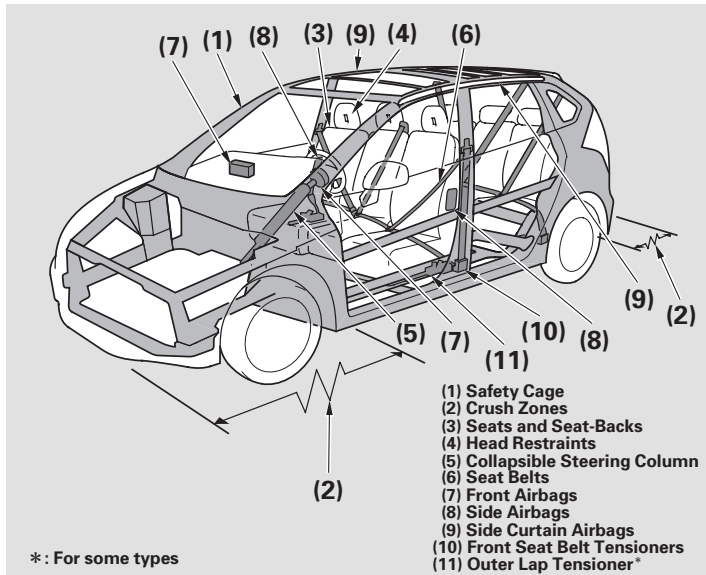

Your vehicle is equipped with many features that work together to protect you and your passengers during a crash.

Some features do not require any action on your part. These include a strong steel framework that forms a safety cage around the passenger compartment, front and rear crush zones, a collapsible steering column, and tensioners that tighten the front seat belts in a crash.

However, you and your passengers can't take full advantage of these features unless you remain sitting in a proper position and **always wear your seat belts**. In fact, some safety features can contribute to injuries if they are not used properly.

The following pages explain how you can take an active role in protecting yourself and your passengers.





Your Vehicle's Safety Features

Seat Belts

Your vehicle is equipped with seat belts in all seating positions.

Your seat belt system also includes an indicator on the instrument panel and a beeper to remind you and your passengers to fasten your seat belts.

Why Wear Seat Belts

Seat belts are the single most effective safety device for adults and larger children. (Infants and smaller children must be properly restrained in child restraint systems.)

Not wearing a seat belt properly increases the chance of serious injury or death in a crash, even though your vehicle has airbags.

In most European Countries there is a law covering the use of seat belts. Please take time to familiarize yourself with the legal requirements of the countries in which you will drive.

⚠ WARNING

Not wearing a seat belt properly increases the chance of serious injury or death in a crash, even though your vehicle has airbags.

Be sure you and your passengers always wear seat belts and wear them properly.

When properly worn, seat belts:

- Keep you connected to the vehicle so you can take advantage of the vehicle's built-in safety features.
- Help protect you in almost every type of crash, including frontal, side, and rear impacts and rollovers.
- Help keep you from being thrown against the inside of the vehicle and against other occupants.
- Keep you from being thrown out of the vehicle.
- Help keep you in a good position should the airbags ever deploy. A good position reduces the risk of injury from an inflating airbag and allows you to get the best advantage from the airbag.





Your Vehicle's Safety Features

Of course, seat belts cannot completely protect you in every crash. But in most cases, seat belts can reduce your risk of serious injury.

What You Should Do:
Always wear your seat belt, and make sure you wear it properly.

WARNING:

- *Seat belts are designed to bear upon the bony structure of the body, and should be worn low across the front of the pelvis or the pelvis, chest and shoulders, as applicable; wearing the lap section of the belt across the abdominal area must be avoided.*
- *Seat belts should be adjusted as firmly as possible, consistent with comfort, to provide the protection for which they have been designed. A slack belt will greatly reduce the protection afforded to the wearer.*
- *Belts should not be worn with straps twisted.*
- *Each belt assembly must only be used by one occupant; it is dangerous to put a belt around a child being carried on the occupant's lap.*





Your Vehicle's Safety Features

Airbags

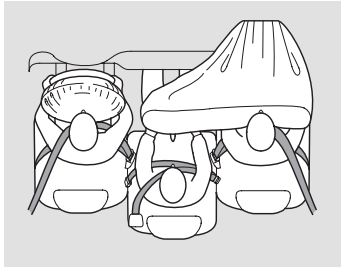

Your vehicle has a Supplemental Restraint System (SRS) with front airbags to help protect the heads and chests of the driver and front seat passengers during a moderate to severe frontal collision (see page 27 for more information on how your front airbags work).

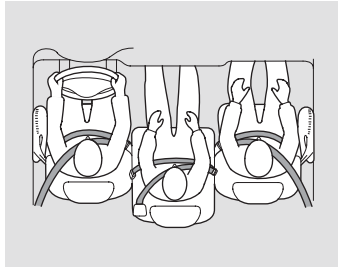

Your vehicle also has side airbags to help protect the upper torso of the driver and the front outer seat passenger during a moderate to severe side impact (see page 28 for more information on how your side airbags work).

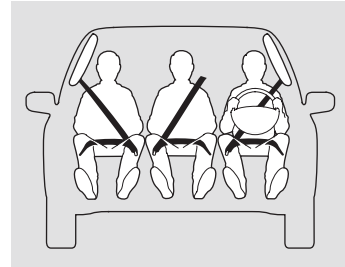

In addition, your vehicle has side curtain airbags to help protect the heads of the driver, the front outer seat passenger and the rear outer seat passengers. (See page 29 for more information on how your side curtain airbags work.)

12 Driver and Passenger Safety





Your Vehicle's Safety Features

The most important things you need to know about your airbags are:

- **Airbags do not replace seat belts.** They are designed to supplement the seat belts.
- **Airbags offer no protection in rear impacts, or minor frontal or side collisions.**
- **Airbags can pose serious hazards.** To do their job, airbags must inflate with tremendous force. So while airbags help save lives, they can cause minor injuries or more serious or even fatal injuries if occupants are not properly restrained or sitting properly.

What you should do: Always wear your seat belt properly, and sit upright, and as far back from the steering wheel while allowing full control of the vehicle. The front passengers should move their seat as far back from the dashboard as possible.

The rest of this section gives more detailed information about how you can maximize your safety.

Remember, however, that no safety system can prevent all injuries or deaths that can occur in severe crashes, even when seat belts are properly worn and the airbags deploy.





Protecting Adults and Teens

Introduction

The following pages provide instructions on how to properly protect the driver, adult passengers, and teenage children who are large enough and mature enough to drive or ride in the front.

See pages 32 – 38 for important guidelines on how to properly protect infants, small children, and larger children who ride in your vehicle.



1. Close the Doors

After everyone has entered the vehicle, be sure the doors and the tailgate are closed.



Your vehicle has a door-open indicator on the instrument panel to indicate when a specific door or the tailgate is not tightly closed.

See page 77 for how the door-open indicator works.

2. Adjust the Front Seats

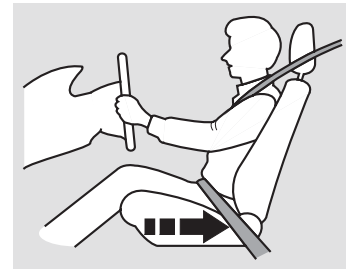

Adjust the driver's seat as far to the rear as possible while allowing you to maintain full control of the vehicle. Have front passengers adjust their seats as far to the rear as possible.

If you sit too close to the steering wheel or dashboard, you can be seriously injured by an inflating front airbag, or by striking the steering wheel or dashboard.





Protecting Adults and Teens

In addition to adjusting the seat, you can adjust the steering wheel up and down, and in and out (see page 95).

If you cannot get far enough away from the steering wheel and still reach the controls, we recommend that you investigate whether some type of adaptive equipment may help.

⚠ WARNING

Sitting too close to a front airbag can result in serious injury or death if the front airbags inflate.

Always sit as far back from the front airbags as possible.

Once a seat is adjusted correctly, rock it back and forth to make sure it is locked in position.

See page 108 for how to adjust the front seats.

3. Adjust the Seat-Backs

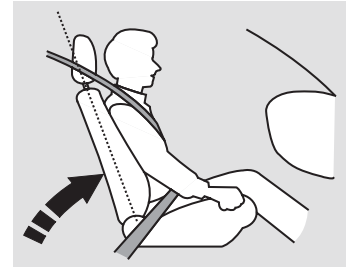

Adjust the driver's seat-back to a comfortable, upright position, leaving ample space between your chest and the airbag cover in the centre of the steering wheel.

Passengers with adjustable seat-backs should also adjust their seat-back to a comfortable, upright position.

CONTINUED





Protecting Adults and Teens

⚠ WARNING

Reclining the seat-back too far can result in serious injury or death in a crash.

Adjust the seat-back to an upright position, and sit well back in the seat.

Reclining a seat-back so that the shoulder part of the belt no longer rests against the occupant's chest reduces the protective capability of the belt. It also increases the chance of sliding under the belt in a crash and being seriously injured. The farther a seat-back is reclined, the greater the risk of injury.

See page 108 for how to adjust the seat-backs.

4. Adjust the Head Restraints

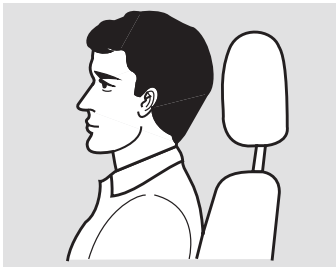

Adjust the driver's head restraint so the back of your head rests against the centre of the restraint.

Have passengers with adjustable head restraints adjust their restraints properly as well. Taller persons should adjust their restraint as high as possible.

When you use the rear seat, adjust the head restraint to the highest position by pulling it upward. You cannot use this head restraint in the lower position.

⚠ WARNING

Improperly positioning head restraints reduces their effectiveness and you can be seriously injured in a crash.

Make sure head restraints are in place and positioned properly before driving.

Properly adjusted head restraints will help protect occupants from whiplash and other crash injuries.

See page 110 for how to adjust the head restraints.





Protecting Adults and Teens

5. Fasten and Position the Seat Belts

Insert the latch plate into the buckle, then tug on the belt to make sure the belt is securely latched. Also check that the belt is not twisted, because a twisted belt can cause serious injuries in a crash.



Position the lap part of the belt as low as possible across your hips, then pull up on the shoulder part of the belt so the lap part fits snugly. This lets your strong pelvic bones take the force of a crash and reduces the chance of internal injuries.

If necessary, pull up on the shoulder belt again to remove any slack, then check that the belt rests across the centre of your chest and over your shoulder.

This spreads the forces of a crash over the strongest bones in your upper body.

⚠ WARNING

Improperly positioning the seat belts can cause serious injury or death in a crash.

Make sure all seat belts are properly positioned before driving.

If the seat belt touches or crosses your neck, or if it crosses your arm instead of your shoulder, you need to adjust the seat belt anchor height.

CONTINUED





Protecting Adults and Teens

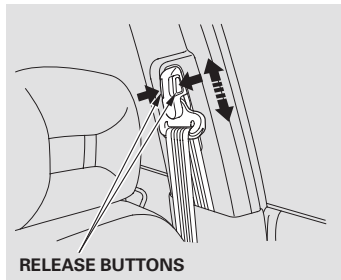

The front outer passenger seat and the driver's seat have adjustable seat belt anchors. To adjust the height of the anchor, press and hold the release buttons and slide the anchor up or down as needed (it has four positions).

Never place the shoulder portion of a lap/shoulder belt under your arm or behind your back. This could cause very serious injuries in a crash.

If a seat belt does not seem to work properly, it may not protect the occupant in a crash.

No one should sit in a seat with an inoperative seat belt. Using a seat belt that is not working properly can result in serious injury or death. Have your dealer check the belt as soon as possible.

See page 21 for additional information about your seat belts and how to take care of them.

6. Maintain a Proper Sitting Position

After all occupants have adjusted their seats and put on seat belts, it is very important that they continue to sit upright, well back in their seats, with their feet on the floor, until the vehicle is parked and the engine is off.

Sitting improperly can increase the chance of injury during a crash. For example, if an occupant slouches, lies down, turns sideways, sits forward, leans forward or sideways, or puts one or both feet up, the chance of injury during a crash is greatly increased.

In addition, an occupant who is out of position in the front seat can be seriously or fatally injured in a crash by striking interior parts of the vehicle or being struck by an inflating front airbag.





Protecting Adults and Teens

If a front outer seat passenger leans sideways and his head is in the deployment path of the side airbag, an inflating side airbag can strike the passenger with enough force to very seriously injure him.

⚠ WARNING

Sitting improperly or out of position can result in serious injury or death in a crash.

Always sit upright, well back in the seat, with your feet on the floor.

Advice for Pregnant Women



If you are pregnant, the best way to protect yourself and your unborn child when driving or riding in a vehicle is to always wear a seat belt, and keep the lap part of the belt as low as possible across the hips.

When driving, remember to sit upright and adjust the seat as far back as possible while allowing full control of the vehicle. When riding as a front passenger, adjust the seat as far back as possible.

This will reduce the risk of injuries to both you and your unborn child that can be caused by a crash or an inflating front airbag.

Each time you have a checkup, ask your doctor if it's okay for you to drive.





Protecting Adults and Teens

Additional Safety Precautions

- **Never let passengers ride in the luggage area or on top of a folded-down back seat.** All passengers must sit in locked, upright seats and be properly restrained by seat belts.
- **Passengers should not stand up or change seats while the vehicle is moving.** A passenger who is not wearing a seat belt during a crash or emergency stop can be thrown against the inside of the vehicle, against other occupants, or out of the vehicle.
- **Two people should never use the same seat belt.** If they do, they could be very seriously injured in a crash.
- **Do not put any accessories on seat belts.** Devices intended to improve occupant comfort or reposition the shoulder part of a seat belt can reduce the protective capability of the seat belt and increase the chance of serious injury in a crash.
- **Do not place hard or sharp objects between yourself and a front airbag.** Carrying hard or sharp objects on your lap, or driving with a pipe or other sharp object in your mouth, can result in injuries if your front airbag inflates.
- **Keep your hands and arms away from the airbag covers.** If your hands or arms are close to an airbag cover, they could be injured if the airbag inflates.
- **Do not attach or place objects on the front airbag covers.** Objects on the covers marked "SRS AIRBAG" could interfere with the proper operation of the airbags or be propelled inside the vehicle and hurt someone if the airbags inflate.
- **Do not attach hard objects on or near a door.** If a side airbag or a side curtain airbag inflates, a cup holder or other hard object attached on or near the door could be propelled inside the vehicle and hurt someone.
- **Do not put a coat hanger or hard objects on a coat hook.** This could result in injuries if your side curtain airbag inflates.





Additional Information About Your Seat Belts

Seat Belt System Components

Your seat belt system includes lap/shoulder belts in all six seating positions. The front seat belts are also equipped with automatic seat belt tensioners.



The seat belt system includes an indicator on the instrument panel and a beeper to remind you and your passengers to fasten your seat belts.

If you turn the ignition switch to ON (II) without fastening your belt, a beeper will sound and the indicator will blink. The beeper will stop after several seconds, but the indicator will stay on until the driver's seat belt is fastened.

If you do not fasten your seat belt before the beeper stops, the indicator will stop blinking but remain on. If you continue driving without fastening your seat belt, the indicator will start blinking again and the beeper will sound at regular intervals.

Lap/Shoulder Belt

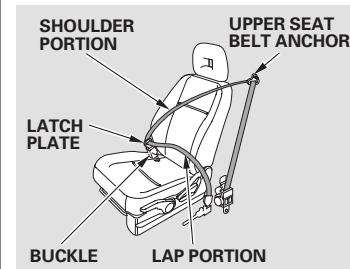

The lap/shoulder belt goes over your shoulder, across your chest, and across your hips.

To fasten the belt, insert the latch plate into the buckle, then tug on the belt to make sure the buckle is latched (see page 17 for how to properly position the belt).

CONTINUED





Additional Information About Your Seat Belts

To unlock the belt, press the red PRESS button on the buckle. Guide the belt across your body so that it retracts completely. After exiting the vehicle, be sure the belt is out of the way and will not get closed in the door.

All seat belts have an emergency locking retractor. In normal driving, the retractor lets you move freely in your seat while it keeps some tension on the belt. During a collision or sudden stop, the retractor automatically locks the belt to help restrain your body.

The seat belts in all rear seating positions and the front centre seat have an additional lockable retractor that must be activated to secure a child restraint (see page 52).

If the shoulder part of the belt is pulled all the way out, the lockable retractor will activate. The belt will retract, but it will not allow the passenger to move freely.

To deactivate the lockable retractor, unlatch the buckle and let the seat belt fully retract. To refasten the seat belt, pull it out only as far as needed.

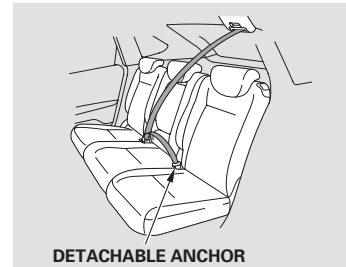

The lap/shoulder belt in the rear centre seat is equipped with a detachable anchor that has two parts: a small latch plate and an anchor buckle.

The detachable seat belt should normally be latched whenever the seat-backs are in an upright position. For more information about the detachable seat belt, see page 117 .





Additional Information About Your Seat Belts

Automatic Seat Belt Tensioners



For added protection, the front seat belts are equipped with automatic seat belt tensioners. When activated, the tensioners immediately tighten the belts to help hold the driver and the front passengers in position.

The tensioners are designed to activate in any collision severe enough to cause the front airbags to deploy.

If a side or side curtain airbag deploys during a side impact, the tensioner on that side of the vehicle will also deploy.

The tensioners can also be activated during a collision in which the front airbags *do not deploy*. In this case, the airbags would not be needed, but the additional restraint could be helpful.

When the tensioners are activated, the seat belts will remain tight until they are unbuckled.



The SRS indicator will come on if there is a problem with your automatic seat belt tensioners (see page 30).

Seat Belt Maintenance

For safety, you should check the condition of your seat belts regularly.

Pull each belt out fully, and look for frays, cuts, burns, and wear. Check that the latches work smoothly and the belts retract easily. If a belt does not retract easily, cleaning the belt may correct the problem (see page 292). Any belt that is not in good condition or working properly will not provide good protection and should be replaced as soon as possible.

WARNING: *No modifications or additions should be made by the user which will either prevent the seat belt adjusting devices from operating to remove slack, or prevent the seat belt assembly from being adjusted to remove slack.*

CONTINUED





Additional Information About Your Seat Belts

If a seat belt is worn during a crash, it must be replaced by the dealer. A belt that has been worn during a crash may not provide the same level of protection in a subsequent crash.

The dealer should also inspect the anchors for damage and replace them if needed. If the automatic seat belt tensioners activate during a crash, they must be replaced.

WARNING: *It is essential to replace the entire assembly after it has been worn in a severe impact even if damage to the assembly is not obvious.*

WARNING: *Care should be taken to avoid contamination of the webbing with polishes, oils and chemicals, and particularly battery acid. Cleaning may safely be carried out using mild soap and water. The belt should be replaced if webbing becomes frayed, contaminated or damaged.*

⚠ WARNING

Not checking or maintaining seat belts can result in serious injury or death if the seat belts do not work properly when needed.

Check your seat belts regularly and have any problem corrected as soon as possible.





Additional Information About Your Seat Belts

Anchorage Points (Front Outer Seat)

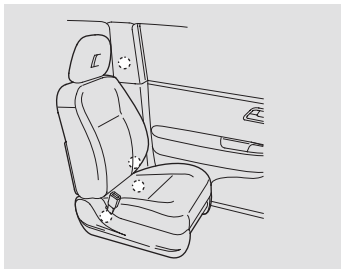

When replacing the seat belts, make certain to use the anchorage points shown in the illustrations.

(Front Centre Seat)



(Rear Seat)

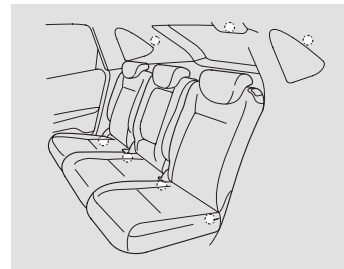

The rear seat has three lap/shoulder belts.





Additional Information About Your Airbags

Airbag System Components

Your airbag system includes:

- Two SRS (supplemental restraint system) front airbags. The driver's airbag is stored in the centre of the steering wheel; the front passenger's airbag is stored in the dashboard. Both are marked "SRS AIRBAG" (see page 27).
- Two side airbags, one for the driver and one for the front outer passenger. The airbags are stored in the outer edges of the seat-backs. Both are marked "SIDE AIRBAG" (see page 28).
- Two side curtain airbags, one for each side of the vehicle. The airbags are stored in the ceiling above the side windows. The front and rear pillars on both sides are marked "SIDE CURTAIN AIRBAG" (see page 29).
- Automatic front seat belt tensioners (see page 23).
- Sensors that can detect a moderate to severe front impact or side impact.
- A sophisticated electronic system that continually monitors information about the sensors, the control unit, and the airbag activators when the ignition switch is in the ON (II) position.
- An indicator on the instrument panel that alerts you to a possible problem with your airbags, sensors, or seat belt tensioners (see page 30).
- Emergency backup power in case your vehicle's electrical system is disconnected in a crash.





Additional Information About Your Airbags

How Your Front Airbags Work

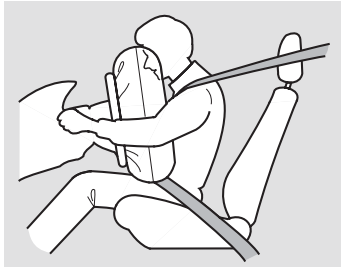

If you ever have a moderate to severe frontal collision, sensors will detect the vehicle's rapid deceleration.

If the rate of deceleration is high enough, the control unit will instantly inflate the driver's and front passengers' front airbags, and activate the automatic seat belt tensioners.

During a frontal crash, your seat belt restrains your lower body and torso, while the tensioner tightens and locks the seat belt to help keep you in place, and the airbag helps protect your head and chest.

Although both airbags normally inflate within a split second of each other, it is possible for only one airbag to deploy.

This can happen if the severity of a collision is at the margin, or threshold, that determines whether or not the airbags will deploy. In such cases, the seat belt will provide sufficient protection, and the supplemental protection offered by the airbag would be minimal.

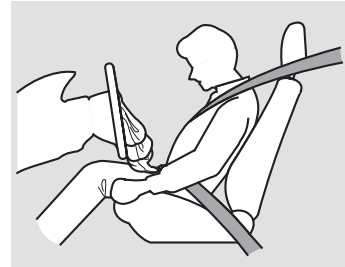

After inflating, the front airbags will immediately deflate, so they won't interfere with the driver's visibility, or the ability to steer or operate other controls.

CONTINUED





Additional Information About Your Airbags

The total time for inflation and deflation is one-tenth of a second, so fast that most occupants are not aware that the airbags deployed until they see them lying in their laps.

After a crash, you may see what looks like smoke. This is actually powder from the airbag's surface. Although the powder is not harmful, people with respiratory problems may experience some temporary discomfort. If this occurs, get out of the vehicle as soon as it is safe to do so.

Dual-Stage Airbags

Your front airbags are dual-stage airbags. This means they have two inflation stages that can be ignited sequentially or simultaneously, depending on crash severity.

In a **more severe** crash, both stages will ignite simultaneously to provide the quickest and greatest protection.

In a **less severe** crash, one stage will ignite first, then the second stage will ignite a split second later. This provides longer airbag inflation time with a little less force.

How Your Side Airbags Work

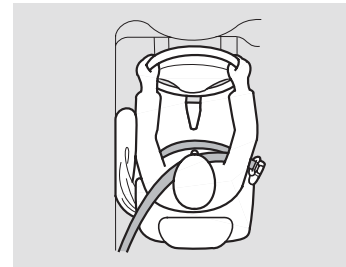

If you ever have a moderate to severe side impact, sensors will detect rapid acceleration and signal the control unit to instantly inflate either the driver's or the passenger's side airbag and activate the seat belt tensioner on the affected side.





Additional Information About Your Airbags

Only one airbag will deploy during a side impact. If the impact is on the passenger's side, the passenger's side airbag will deploy even if there is no passenger.

To get the best protection from the side airbags, front seat occupants should wear their seat belts and sit upright and well back in their seats.

If a front outer seat passenger leans sideways and his head is in the deployment path of the side airbag, he can be seriously injured by an inflating side airbag. An inflating side airbag can strike the child with enough force to kill or very seriously injure a child. For the information of the side airbags hazards, see pages 36 and 60.

How Your Side Curtain Airbags Work

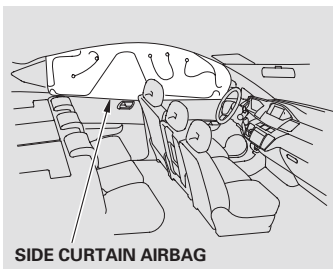

In a moderate to severe side impact, sensors will detect rapid acceleration and signal the control unit to instantly inflate the side curtain airbag and activate the seat belt tensioner on the driver's or the passenger's side of the vehicle.

If the impact is on the passenger's side, the passenger's side curtain airbag will inflate even if there are no occupants on that side of the vehicle.

To get the best protection from the side curtain airbags, occupants should wear their seat belts and sit upright and well back in their seats.





Additional Information About Your Airbags

How the SRS Indicator Works



The SRS indicator alerts you to a potential problem with your airbags or seat belt tensioners.

When you turn the ignition switch to the ON (II) position, this indicator comes on for several seconds then goes off. This tells you the system is working properly.

If the indicator comes on at any other time, or does not come on at all, you should have the system checked by your dealer. For example:

- If the SRS indicator does not come on after you turn the ignition switch to the ON (II) position.
- If the indicator stays on after the engine starts.
- If the indicator comes on or flashes on and off while you drive.

If you see any of these indications, the airbags and seat belt tensioners may not work properly when you need them.

⚠ WARNING

Ignoring the SRS indicator can result in serious injury or death if the airbag systems or tensioners do not work properly.

Have your vehicle checked by a dealer as soon as possible if the SRS indicator alerts you to a possible problem.

Airbag Service

Your airbag systems and automatic seat belt tensioners are virtually maintenance free, and there are no parts you can safely service. However, you must have your vehicle serviced if:

- **An airbag ever inflates.** Any airbag that has deployed must be replaced along with the control unit and other related parts. Any seat belt tensioner that activates must also be replaced.

Do not try to remove or replace any airbag by yourself. This must be done by an authorized dealer or a knowledgeable body shop.

- **The SRS indicator alerts you to a problem.** Take your vehicle to an authorized dealer as soon as possible. If you ignore this indication, your airbags may not operate properly.





Additional Information About Your Airbags

Handling is allowed by trained personnel only. It is prohibited to remove the airbag unit/belt-tensioner from the vehicle. In case of malfunction, shutdown or after airbag inflation/belt-tensioner operation you have to ask a qualified shop for repair or removal.

Additional Safety Precautions

- **Do not attempt to deactivate your airbags.** Together, airbags and seat belts provide the best protection.
- **Do not tamper with airbag and automatic seat belt tensioner components or wiring for any reason.** Tampering could cause the airbags and automatic seat belt tensioners to deploy, possibly causing very serious injury.
- **Do not expose the front seat-backs to liquid.** If water or another liquid soaks into the seat-back, it can prevent the side airbag system from working properly.
- **Do not cover or replace seat-back covers without consulting your dealer.** Improperly replacing or covering front seat-back covers can prevent your side airbags from inflating during a side impact.





Protecting Children – General Guidelines



Children depend on adults to protect them. However, despite their best intentions, many adults do not know how to properly protect child passengers.

If you have children, or ever need to drive with a child in your vehicle, be sure to read this section. It begins with important general guidelines, then presents special information for infants, small children, and larger children.

All Children Must Be Restrained
Each year, many children are injured or killed in vehicle crashes because they are either unrestrained or not properly restrained. In fact, vehicle accidents are the number one cause of the death of children ages 12 and under.

To reduce the number of child deaths and injuries, infants and children should be properly restrained when they ride in a vehicle.

Infants and small children must be restrained in an approved child restraint system that is properly secured to the vehicle (see pages 39 – 59).

⚠ WARNING

Children who are unrestrained or improperly restrained can be seriously injured or killed in a crash.

Any child too small for a seat belt should be properly restrained in an approved child restraint system. A larger child should be properly restrained with a seat belt and use a booster seat if necessary.

Larger children must be restrained with a lap/shoulder belt and ride on a booster seat until the seat belt fits them properly (see pages 60 – 64).





Protecting Children – General Guidelines

In most countries, child restraint systems must meet the specifications of the ECE 44 regulation.

In many countries, the law requires children younger than 12 years of age and less than 150 cm (60 in) in height to be secured in an officially approved and suitable child restraint system. In those countries, officially approved and suitable child restraint systems must therefore be used in order to transport a child on any passenger seat whatsoever. Please check your local legal requirements.

All Children Should Sit in a Back Seat

According to crash statistics, children of all ages and sizes are safer when they are restrained in a back seat. It is recommended that all children age 12 and under be properly restrained in a back seat.

In this vehicle, small or larger children may also be restrained in the front centre seat. When using a front facing child restraint system in the front centre seat, position the seat to its rearmost. Never put a rearward facing child restraint system in any front seat.

Children who ride in back are less likely to be injured by striking interior vehicle parts during a collision or hard braking. Also, children cannot be injured by an inflating front airbag when they ride in the back.

The Passenger's Front Airbag Poses Serious Risks

Front airbags have been designed to help protect adults in a moderate to severe frontal collision. To do this, the passenger's front airbag is quite large, and it can inflate with enough force to cause very serious injuries.

Infants

Never put a rearward facing child restraint system in the front seats of a vehicle equipped with a passenger's front airbag. If the airbag inflates, it can hit the back of the child restraint system with enough force to kill or very seriously injure an infant.

CONTINUED





Protecting Children – General Guidelines

As required by E.C.E Regulation No. 94;



If the passenger's front airbag inflates, it can hit the rearward facing child restraint system with great force. The rearward facing child restraint system can be dislodged or struck with enough force to cause very serious injury to the infant.

Small Children

Placing a front facing child restraint system in the front seats of a vehicle equipped with a passenger's front airbag can be hazardous. If the vehicle seat is too far forward, or the child's head is thrown forward during a collision, an inflating front airbag can strike the child with enough force to kill or very seriously injure a small child.

In this vehicle, small children may also be restrained in the front centre seat. When using a front facing child restraint system in the front centre seat, position the seat to its rearmost.

Larger Children

Children who have outgrown child restraint systems are also at risk of being injured or killed by an inflating passenger's front airbag. Whenever possible, larger children should sit in the back seat, in a booster seat if needed, and be properly restrained with a seat belt (see page 60 for important information about protecting larger children).

In this vehicle, larger children may also be restrained in the front centre seat. When using a front facing child restraint system in the front centre seat, position the seat to its rearmost.

In all cases observe the legal requirements of the countries in which you will drive.





Protecting Children – General Guidelines

On some types

To remind you of the passenger's front airbag hazards, your vehicle has warning labels on the windscreen, on the front passenger's doorjamb, and on the sun visors. Please read and follow the instructions on these labels.

As required by E.C.E Regulation No. 94;





Protecting Children – General Guidelines

The Side Airbag Poses Serious Risks

Side airbags have been designed to help protect adults in a moderate to severe side impact. If any part of a child's body is in the path of a deploying airbag, an inflating side airbag can strike the child with enough force to kill or very seriously injure a child.

To remind you of the side airbags hazards, your vehicle also has the safety label on each front doorjamb.

▲ WARNING



Leaning over the front door can result in serious injury or death if the side airbag inflates.

Always sit upright with their back against the seat-back.

If You Must Drive with Several Children

Your vehicle has three seating positions in the back seat and one front centre seat where children can be properly restrained. If you ever have to carry a group of children, and a child must ride in the front outer seat:

- Place the largest child in the front outer seat, provided the child is large enough to wear the lap/shoulder belt properly (see page 60).
- Move the vehicle seat as far to the rear as possible (see page 14).
- Have the child sit upright and well back in the seat (see page 18).
- Make sure the seat belt is properly positioned and secured (see page 17).





Protecting Children – General Guidelines

If a Child Requires Close Attention

Many parents say they prefer to put an infant or a small child in the front passenger seat so they can watch the child, or because the child requires attention.

Placing a child in the front outer seat exposes the child to hazards in a frontal collision or a side impact, and placing in the front centre seat distracts the driver from the important tasks of driving, putting both of you at risk.

If a child requires close physical attention or frequent visual contact, we strongly recommend that another adult ride with the child in the back seat. The back seat is far safer for a child than the front.

Additional Safety Precautions

- **Never hold an infant or child on your lap.** If you are not wearing a seat belt in crash, you could be thrown forward and crush the child against the dashboard or a seat-back. If you are wearing a seat belt, the child can be torn from your arms and be seriously hurt or killed.
 - **Never put a seat belt over yourself and a child.** During a crash, the belt could press deep into the child and cause serious or fatal injuries.
 - **Never let two children use the same seat belt.** If they do, they could be very seriously injured in a crash.
- **Use the childproof door locks to prevent children from opening the rear doors.** This can prevent children from accidentally falling out (see page 101).
 - **WARNING:** Use the main power window switch to prevent children from opening the windows. Using this feature will prevent children from playing with the windows, which could expose them to hazards or distract the driver (see page 123).
 - **WARNING:** Always take the ignition key with you whenever you leave the vehicle alone (with other occupants).

CONTINUED





Protecting Children – General Guidelines

- **Lock all doors and the tailgate when your vehicle is not in use.** Children who play in vehicles can accidentally get trapped inside. Teach your children not to play in or around vehicles.

- **Make sure any unused seat belt that a child can reach is buckled, the lockable retractor is activated, and the belt is fully retracted and locked.** If a child wraps a loose seat belt around their neck, they can be seriously or fatally injured. (See pages 53 and 55 for how to activate and deactivate the lockable retractor.)

- **Do not leave children alone in a vehicle.** Leaving children without adult supervision is illegal in some countries and can be very hazardous.

For example, infants and small children left in a vehicle on a hot day can die from heatstroke. A child left alone with the key in the ignition switch can accidentally set the vehicle in motion, possibly injuring themselves or others.

- **Keep vehicle keys/remote transmitters out of the reach of children.** Even very young children learn how to unlock vehicle doors, turn on the ignition switch, and open the tailgate, which can lead to accidental injury or death.

“Never let children kneel on seats or stand while the vehicle is in motion. The violent forces created during emergency braking will cause the children to be thrown forward. The children could be seriously injured or killed.”





Protecting Infants and Small Children

Protecting Infants

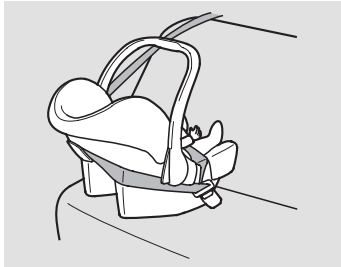

Child Restraint System Type

An infant must be properly restrained in a rear-facing, reclining child restraint system until the child reaches the restraint system maker's weight or height limit for the restraint system, and the child is at least one year old.

Only a rearward facing child restraint system provides proper support for a baby's head, neck and back.

Two types of restraints may be used: a restraint system designed exclusively for infants, or a convertible restraint system used in the rearward facing, reclining mode.

For EU countries, refer to page 46 for the recommended child restraint system.

Do not put a rearward facing child restraint system in a forward-facing position. If placed facing forward, an infant could be very seriously injured during a frontal collision.

Rearward Facing Child Restraint System Placement

In this vehicle, a rearward facing child restraint system can be placed in any seating position in the back seat, but not in the front. **Never put a rear-facing child restraint system in the front seats.**

For EU countries, an approved rearward facing child restraint system should be placed in any seating position in the back seat (see page 46).

If the passenger's front airbag inflates, it can hit the back of the restraint with enough force to kill or seriously injure an infant.

CONTINUED





Protecting Infants and Small Children

When properly installed, a rearward facing child restraint system may prevent the driver or a front passenger from moving their seat as far back as recommended, or from locking their seat-back in the desired position.

In either situation, we strongly recommend that you install the child restraint system directly behind one of the front passenger seats, move the front seat as far forward as needed, and leave it unoccupied. Or you may wish to get a smaller child restraint system.



⚠ WARNING

Placing a rearward facing child restraint system in the front seats can result in serious injury or death if the passenger's front airbag inflates.

Always place a rearward facing child restraint system in the back seat, not the front.

As required by E.C.E Regulation No. 94;

⚠ WARNING



DO NOT place rear-facing child seat on this seat with airbag.

DEATH OR SERIOUS INJURY can occur.

If the passenger's front airbag inflates, it can hit the rearward facing child restraint system with great force. The rearward facing child restraint system can be dislodged or struck with enough force to cause very serious injury to the infant.





Protecting Infants and Small Children

Protecting Small Children



Child Restraint System Type

A child who is at least one year old, and who fits within the child restraint system maker's weight and height limits, should be restrained in a front facing, upright child restraint system.

Of the different restraint systems available, we recommend those that have a five-point harness system as shown.

We also recommend that a small child uses the child restraint system as long as possible, until the child reaches the weight or height limit for the restraint system.

For EU countries, refer to page 46 for the recommended child restraint system.

Child Restraint System Placement

We recommend placing a front facing child restraint system in a back seat or the front centre seat.

Placing a front facing child restraint system in the front outer seat of a vehicle equipped with a passenger's airbag can be hazardous. If the front outer seat is too far forward, or the child's head is thrown forward during a collision, an inflating airbag can strike the child with enough force to cause very serious or fatal injuries.

CONTINUED





Protecting Infants and Small Children

In this vehicle, small or larger children may also be restrained in the front centre seat.

When a small child is restrained in the front centre seat, position the seat to its rearmost. However we recommend putting children at the back to avoid possible distraction to the driver.

If it is necessary to put a front facing child restraint system in the front, move the vehicle seat as far to the rear as possible, and be sure the child restraint system is firmly secured to the vehicle and the child is properly strapped in the restraint system.

▲ WARNING

Placing a front facing child restraint system in the front outer seat can result in serious injury or death if the front airbag inflates.

If you must place a front facing child restraint system in front outer seat, move the vehicle seat to its rearmost, and properly restrain the child.





Selecting a Child Restraint System

When buying a child restraint system, you need to choose either a conventional child restraint system, or one designed for use with the lower anchorages and tethers.

Conventional child restraint systems must be secured to a vehicle with a seat belt, whereas lower anchorages system-compatible child restraint systems are secured by attaching the restraint to hardware built into the two outer seating positions in the back seat and the front centre seat.

Since lower anchorages system-compatible child restraint systems are easier to install and reduce the possibility of improper installation, we recommend selecting this style.

We also recommend selecting a lower anchorages system-compatible child restraint system with a rigid, rather than a flexible, anchor (see page 47).

In EU countries, a child restraint system with a flexible anchor is not available.

In seating positions and vehicles not equipped with lower anchorages, a lower anchorages system-compatible child restraint system can be installed using a seat belt.

Whatever type of child restraint you choose, to provide proper protection, a child restraint system should meet three requirements:

1. The child restraint system should meet safety standards. In most countries, child restraint systems must meet the specifications of the ECE 44 regulation. Look for the approval mark on the system and the manufacturer's statement of compliance on the box.

The manufacturer of the vehicle does not assume any responsibility for damage which would be caused by a defect inherent in the recommended child restraint system.

CONTINUED





Selecting a Child Restraint System

2. The child restraint system should be of the proper type and size to fit the child.

Rearward facing for infants, front facing for small children.

Make sure the restraint system fits your child. Check the manufacturer's instructions and labels for height and weight limits.

3. The child restraint system should fit the vehicle seating position (or positions) where it will be used.

Before purchasing a conventional child restraint system, or using a previously purchased one, we recommend that you test the restraint system in the specific vehicle seating position or positions where the child restraint system will be used.

For EU countries, refer to page 46 for the recommended child restraint system.





Installing a Child Restraint System

After selecting a proper child restraint system and a good place to install the restraint system, there are three main steps in installing the restraint system:

1. Properly secure the child restraint system to the vehicle. All child restraint systems must be secured to the vehicle with the lap part of a lap/shoulder belt or with the lower anchorages system. A child whose restraint system is not properly secured to the vehicle can be endangered in a crash.

If you use a lap/shoulder belt without an additional lockable retractor, be sure you install a locking clip on the seat belt (see page 56).

2. Make sure the child restraint system is firmly secured. After installing a child restraint system, push and pull the restraint system forward and from side-to-side to verify that it is secure.

A child restraint system secured with a seat belt should be installed as firmly as possible. However, it does not need to be "rock solid." Some side-to-side movement can be expected and should not reduce the child restraint system's effectiveness.

If the child restraint system is not secure, try installing it in a different seating position, or use a different style of child restraint system that can be firmly secured.

For EU countries, refer to page 46 for the recommended child restraint system.

3. Secure the child in the back seat.

Make sure the child is properly strapped in the child restraint system according to the child restraint system maker's instructions. A child who is not properly secured in a child restraint system can be seriously injured in a crash.

The following pages provide the recommended child restraint systems for EU countries and guidelines on how to properly install a child restraint system. A front facing child restraint system is used in all examples, but the instructions are the same for a rearward facing child restraint system.





Installing a Child Restraint System

Child Restraint System for EU Countries

There are many different child restraint systems available. Not all are suitable for use with your vehicle. Please refer to the table below showing which category of child restraint system can be used for each seating position.

Mass Group		Seating Position			
		Front Passenger		Rear Passenger	
		Outboard	Centre	Outboard	Centre
group 0	Up to 10 kg	X	X	Honda BABY-SAFE	Honda BABY-SAFE
group 0+	Up to 13 kg	X	X	IL (Honda BABY-SAFE ISO FIX) or Honda BABY-SAFE	Honda BABY-SAFE
group I	9 kg to 18 kg	UF*	IUF (Size class A, B1, B)* or Honda LORD*	IUF (Size class A, B1, B) or Honda LORD	Honda LORD
group II	15 kg to 25 kg	UF*	Honda KID	Honda KID	Honda KID
group III	22 kg to 36 kg	UF*	Honda KID	Honda KID	Honda KID

IL: Suitable for particular ISO FIX child restraint systems (CRS) given in this table.

UF: Suitable for forward-facing "universal" category restraints approved for use in this mass group

IUF: Suitable for forward-facing ISOFIX child restraints systems of universal category approved for use in this mass group

X: Seat position not suitable for children in this mass group.

*: Move the front seat to its rearmost position.

If you intend to use a universal category ISOFIX forward facing child restraint system, please refer carefully to the size class as indicated on the packaging and labelling of the child restraint. Only size classes A, B1 and B are suitable for use with your vehicle. Do not use size class C, D, E, F or G restraints.

The particular child restraints in the above table are Honda Genuine Parts which are available from your dealer.

46 Driver and Passenger Safety





Installing a Child Restraint System

⚠ WARNING

The use of any child restraint system which is not suitable for your vehicles would not properly secure the infant or child who could therefore be killed or seriously injured.

Your vehicle is equipped with lower anchorages at the outer seating positions on the rear seat and the front centre seat. These anchorages are only to be used with a child restraint system designed to be attached to the lower anchorages. Refer to the next column for how to install a child restraint system to the lower anchorages.

Installing a Child Restraint System with the Lower Anchorages

Your vehicle is equipped with lower anchorages at the outer rear seats and the front centre seat. These anchorages are located between the seat-back and seat bottom, and are to be used only with a child restraint system designed for use with the lower anchorages.



CONTINUED





Installing a Child Restraint System

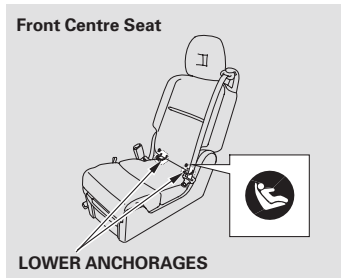

The location of each lower anchorage is indicated by a small button above the anchorage point.

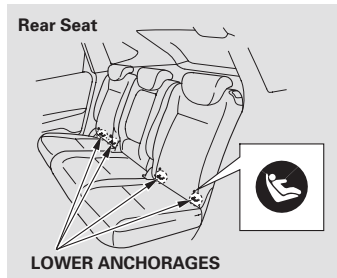

For EU countries, refer to page 46 for the recommended child restraint system.

To install a child restraint system designed to be attached to the lower anchorages:

1. If you install the child restraint system to the front centre seat, position the rear centre seat at least one position back. Then, position the front centre seat to its rearmost position.

For more information about the front centre seat, see page 109 .

2. Move the seat belt buckle or centre seat belt away from the lower anchorages.
3. Make sure there are no objects near the anchorages that could prevent a secure connection between the child restraint system and the anchorages.





Installing a Child Restraint System

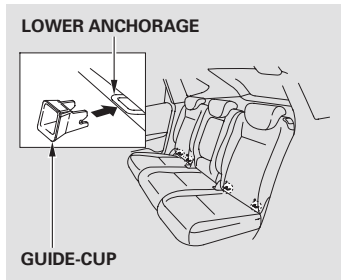

4. *On some child restraint systems*
You may use optional guide-cups that came with your child restraint system to install it to the lower anchorages without damaging the seat surface.

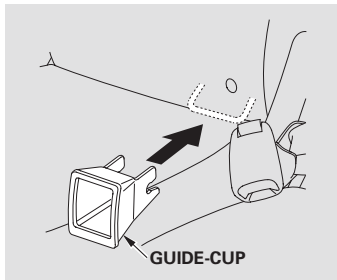

Attach the guide-cups to the lower anchorages as shown in the illustration.

When using the guide-cups, always follow the child restraint system manufacturer's instructions.

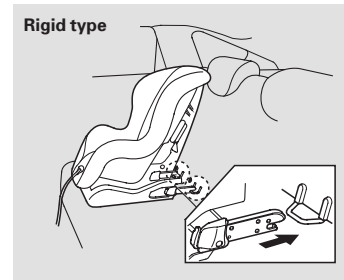

5. Place the child restraint system on the vehicle seat, then attach the child restraint system to the lower anchorages according to the child restraint system maker's instructions.

Some child restraint systems designed for use with lower anchorages have a rigid-type connector as shown above.

CONTINUED





Installing a Child Restraint System

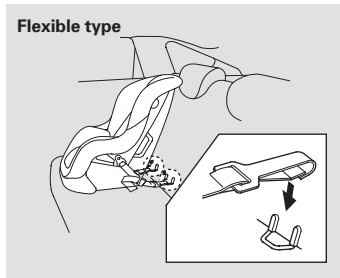

Other child restraints have a flexible-type connector as shown above.

6. Whatever type you have, follow the child restraint system maker's instructions for adjusting or tightening the fit.

Flexible type child restraint system is available in some countries. In EU countries, this type is not available.

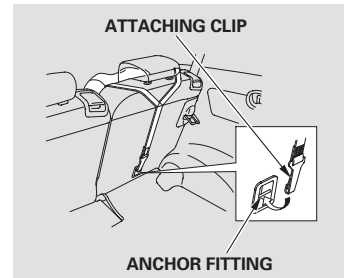

7. Attach the attaching clip to the anchor fitting, making sure the strap is not twisted.

The above illustration shows how the attaching clip should be routed in EU countries.





Installing a Child Restraint System

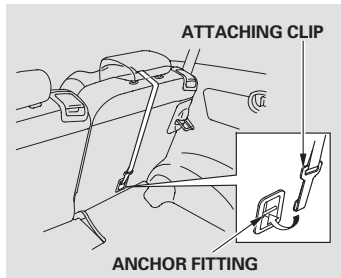

On some models
Lift the head restraint, then route the tether strap over the seat-back and through the head restraint legs.

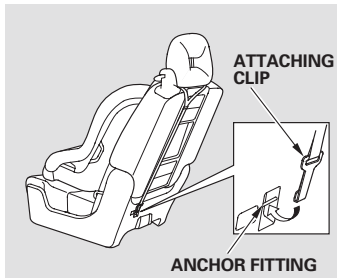

8. Tighten the tether strap according to the child restraint system maker's instructions.

9. Push and pull the child restraint system forward and from side-to-side to verify that it is secure.

The design and suitability of the child restraint systems must be carefully checked with the child restraint system manufacturer concerned and the seller of those systems. If you are not sure, consult your dealer before purchasing this type of child restraint system.





Installing a Child Restraint System

Installing a Child Restraint System with a Lap/Shoulder Belt
When not using the lower anchorages system, all child restraint systems must be secured to the vehicle with the lap part of a lap/shoulder belt.

In addition, the lap/shoulder belts in the back seating positions and the front centre seat have a lockable retractor that must be activated to secure a child restraint system.

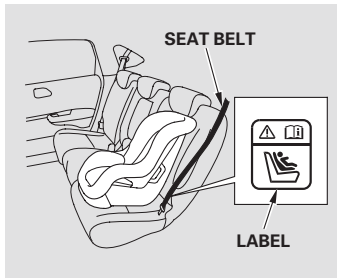

The seat belt with a lockable retractor has a label as shown in the illustration above.

To properly route a lap/shoulder belt through a child restraint system, follow the restraint system maker's instructions.

For EU countries, refer to page 46 for installing a child restraint system.

The procedures in the following pages are described based on a child restraint system available in EU countries.

1. Place the child restraint system in the desired back seating position or front centre position. Make sure the child restraint is positioned well back in the seat-back.

If you install the child restraint system to the front centre seat, position the rear centre seat at least one position back. Then, position the front centre seat to its rearmost position.





Installing a Child Restraint System



2. Route the belt through the restraint according to the restraint system maker's instructions, then insert the latch plate into the buckle.



3. To activate the lockable retractor, slowly pull the shoulder part of the belt all the way out until it stops.

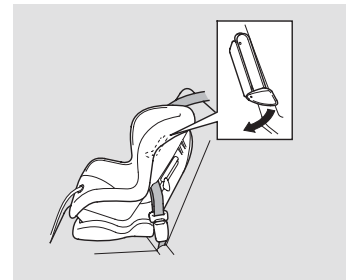

4. Push down the tab. Route the shoulder part of the belt into the slit at the side of the restraint, then let the belt feed back into the retractor.

5. After the belt has retracted, tug on it. If the belt is locked, you will not be able to pull it out. If you can pull the belt out, it is not locked, and you will need to repeat these steps.

CONTINUED





Installing a Child Restraint System

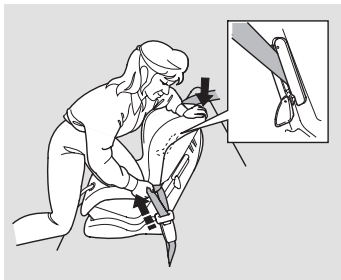

6. After confirming that the belt is locked, grab the shoulder part of the belt near the buckle, and pull up to remove any slack from the lap part of the belt. Remember, if the lap part of the belt is not tight, the child restraint system will not be secure.

To remove slack, it may help to put weight on the child restraint system, or push on the back of the restraint system while pulling up on the belt.

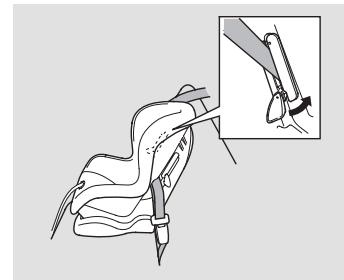

7. Secure the belt in the slit by pushing up the tab. Make sure the belt is not twisted and it is positioned properly in the slit.





Installing a Child Restraint System

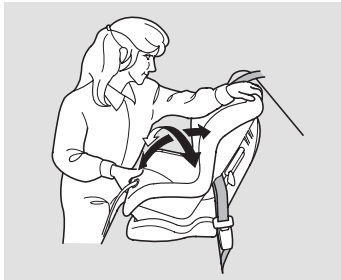

8. Push and pull the child restraint system forward and from side-to-side to verify that it is secure enough to stay upright during normal driving manoeuvres. If the child restraint system is not secure, unlatch the belt, allow it to retract fully, then repeat these steps.

To deactivate the lockable retractor and remove a child restraint system, unlatch the buckle, unrout the seat belt, and let the belt fully retract.

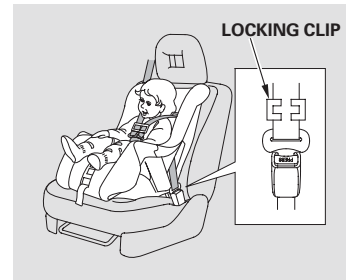

When you secure a child restraint system with a lap/shoulder belt, be sure you install a locking clip on the seat belt (see page 56).





Installing a Child Restraint System

Using a Seat Belt Locking Clip

On vehicles without lockable retractor fitted to the seat where the child is positioned

Always use a seat belt locking clip when you secure a child restraint system to your vehicle with a lap/shoulder belt. This helps prevent the restraint system from shifting position or overturning.

A locking clip is usually included with the child restraint system. If you need a clip, contact the seat's manufacturer or a store that sells child restraints.

If it is necessary to put a front facing child restraint system in the front, move the vehicle seat as far to the rear as possible, be sure the child restraint system is firmly secured to the vehicle, and the child is properly strapped in the restraint system (see page 41).

To install a locking clip, do the following:

1. Place the child restraint in the seat with a lap/shoulder belt. Route the lap/shoulder belt through the restraint according to the seat manufacturer's instructions.
2. Insert the latch plate into the buckle. Pull on the shoulder part of the belt to make sure there is no slack in the lap portion.
3. Tightly grasp the belt near the latch plate. Pinch both parts of the belt together so they won't slip through the latch plate. Unbuckle the seat belt.

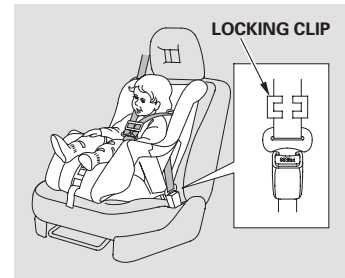

4. Install the locking clip as shown. Position the clip as close as possible to the latch plate.
5. Insert the latch plate into the buckle. Push and pull on the child restraint system to verify that it is held firmly in place. If it is not, repeat these steps until the restraint is secure.





Installing a Child Restraint System

Installing a Child Restraint System with a Tether

Children riding in vehicles should be restrained to minimize the risk of injury in the event of an accident.

(Front Centre Seat)

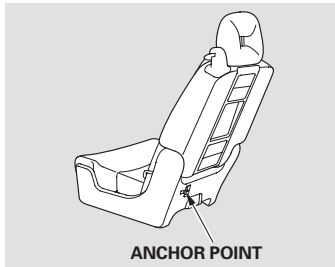

A child restraint system with a tether can be installed in the two outer back seats and the front centre seat, using one of the anchor points shown in the illustrations.

(Rear Seat)

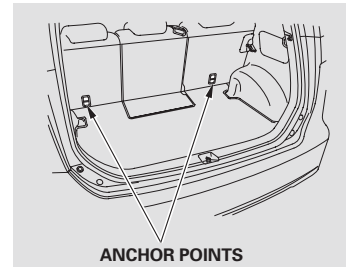

Since a tether can provide additional security to the lap/shoulder belt installation, we recommend using a tether whenever one is required or available. (The owners may check with the child restraint system maker to determine whether a tether is available for a particular child restraint system.)

CONTINUED





Installing a Child Restraint System

Using an Anchor Fitting

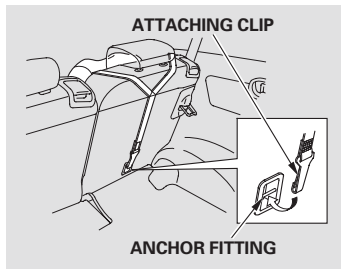

1. After properly securing the child restraint system (see page 47), route the tether strap over the seat-back and on both sides of the head restraint as shown.

The above illustration shows how the tether strap should be routed in EU countries.

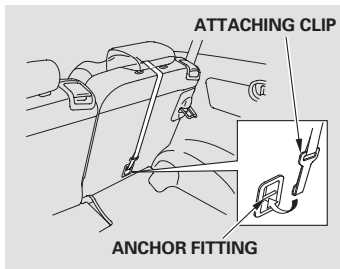

- On some models*
Lift the head restraint, then route the tether strap over the seat-back and through the head restraint legs.

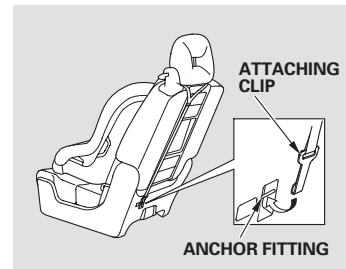

2. Attach the attaching clip to the anchor fitting, making sure the strap is not twisted.
3. Tighten the tether strap according to the child restraint system maker's instructions.





Installing a Child Restraint System

To attach the tether to the child restraint system, follow the child restraint system maker's instructions.

When the child restraint system is used, follow the instructions that came with the child restraint system.

WARNING: *Child restraint anchorages are designed to withstand only those loads imposed by correctly fitted child restraints. Under no circumstances are they to be used for adult seat belts, harnesses or for attaching other items or equipment to the vehicle.*

⚠ WARNING

Make sure the seat-backs are latched securely before driving.





Protecting Larger Children

When a child reaches the recommended weight or height limit for a front facing child restraint system, the child should sit in the back seat on a booster and wear a lap/shoulder belt.

The following pages give instructions on how to check proper seat belt fit, what kind of booster seat to use if one is needed, and important precautions for a child who must sit in front.



⚠ WARNING

Allowing a larger child age 12 or under to sit in front outer seat can result in injury or death if the passenger's front airbag inflates.

If a larger child must ride in front outer seat, move the vehicle seat to its rearmost, use a booster seat if needed, have the child sit up properly and wear the seat belt properly.

⚠ WARNING

Leaning over the front door can result in serious injury or death if the side airbag inflates.

Always sit upright with their back against the seat-back.





Protecting Larger Children

Checking Seat Belt Fit



To determine if a lap/shoulder belt properly fits a child, have the child put on the seat belt, then ask yourself:

1. Does the child sit all the way back against the seat?
2. Do the child's knees bend comfortably over the edge of the seat?

3. Does the shoulder belt cross between the child's neck and arm?
4. Is the lap part of the belt as low as possible, touching the child's thighs?
5. Will the child be able to stay seated like this for the whole trip?

If you answer yes to all these questions, the child is ready to wear the lap/shoulder belt correctly. If you answer no to any question, the child needs to ride on a booster seat.

Using a Booster Seat



A child who has outgrown a front facing child restraint system should ride in the back seat or front centre seat, and use a booster seat until the lap/shoulder belt fits them properly without the booster.

CONTINUED





Protecting Larger Children

Booster seats can be high-back or low-back. Whichever style you select, make sure the booster seat meets approved safety standards (see page 43) and that you follow the booster seat maker's instructions.

If a child who uses a booster must ride in front outer seat, move the vehicle seat to its rearmost, and be sure the child is wearing the seat belt properly.

A child may continue using a booster seat until the tops of their ears are even with the top of the vehicle's or booster's seat-back. A child of this height should be tall enough to use the lap/shoulder belt without a booster seat.

For EU countries, refer to page 46 for the booster seat placement.

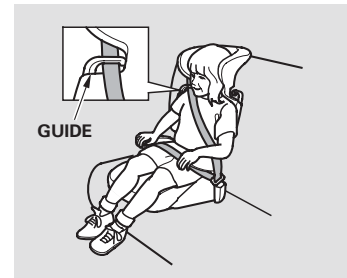

A back-rest may be available for a specific booster seat. Install the back-rest to the booster seat and adjust it to the vehicle seat according to the booster seat maker's instructions. Make sure the seat belt is properly routed through the guide at the shoulder of the back-rest and the belt does not touch and cross the child's neck (see page 17).





Protecting Larger Children

When Can a Larger Child Sit in Front

It is recommended that all children ages 12 and under be properly restrained in the back seat or front centre seat.

The back seat is the safest place for a child of any age or size. The front centre seat is as safe as the back seat, however we recommend positioning children in the back to avoid possible distraction to the driver.

If the passenger's front airbag inflates in a moderate to severe frontal collision, the airbag can cause serious injuries to a child who is unrestrained, improperly restrained, sitting too close to the airbag, or out of position.

The side airbag also poses risks. If any part of a larger child's body is in the path of a deploying side airbag, the child could receive possibly serious injuries.

Of course, children vary widely. And while age may be one indicator of when a child can safely ride in front, there are other important factors you should consider.

Physical Size

Physically, a child must be large enough for the lap/shoulder belt to properly fit (see pages 17 and 60). If the seat belt does not fit properly, with or without the child sitting on a booster seat, the child should not sit in front.

Maturity

To safely ride in front, a child must be able to follow the rules, including sitting properly, and wearing the seat belt properly throughout a ride.

CONTINUED





Protecting Larger Children

If you decide that a child can safely ride up front, be sure to:

- Carefully read the owner's manual, and make sure you understand all seat belt instructions and all safety information.
- Move the vehicle seat to the rear-most position.
- Have the child sit up straight, back against the seat, and feet on or near the floor.
- Check that the child's seat belt is properly and securely positioned.
- Remind the child not to lean toward the door.
- Supervise the child. Even mature children sometimes need to be reminded to fasten the seat belts or sit properly.

Additional Safety Precautions

- ***Do not let a child wear a seat belt across the neck.*** This could result in serious neck injuries during a crash.
- ***Do not let a child put the shoulder part of a seat belt behind the back or under the arm.*** This could cause very serious injuries during a crash. It also increases the chance that the child will slide under the belt in a crash and be injured.
- ***Two children should never use the same seat belt.*** If they do, they could be very seriously injured in a crash.
- ***Do not put any accessories on a seat belt.*** Devices intended to improve a child's comfort or reposition the shoulder part of a seat belt can make the belt less effective and increase the chance of serious injury in a crash.





Carbon Monoxide Hazard

Your vehicle's exhaust contains carbon monoxide gas. Carbon monoxide should not enter the vehicle in normal driving if you maintain your vehicle properly and follow the information on this page.

Have the exhaust system inspected for leaks whenever:

- The vehicle is raised for an oil change.
- You notice a change in the sound of the exhaust.
- The vehicle was in an accident that may have damaged the underside.

⚠ WARNING



Carbon monoxide gas is toxic. Breathing it can cause unconsciousness and even kill you.

Avoid any enclosed areas or activities that expose you to carbon monoxide.

High levels of carbon monoxide can collect rapidly in enclosed areas, such as a garage. Do not run the engine with the garage door closed. Even with the door open, run the engine only long enough to move the vehicle out of the garage.

With the tailgate open, airflow can pull exhaust gas into your vehicle's interior and create a hazardous condition. If you must drive with the tailgate open, open all the windows, and set the climate control system as shown below.

If you must sit in your parked vehicle with the engine running, even in an unconfined area, adjust the climate control system as follows:

1. Select the  mode.
2. Select the  mode.
3. Set the fan speed to high.
4. Set the temperature control to a comfortable setting.





Safety Labels

These labels are in the locations shown. They warn you of potential hazards that could cause serious injury or death. Read these labels carefully.

If a label comes off or becomes hard to read, contact your dealer for a replacement.

The label shown below is attached to the back of the bonnet.

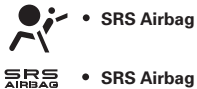

• Safety alert symbol



• Follow service manual instructions carefully

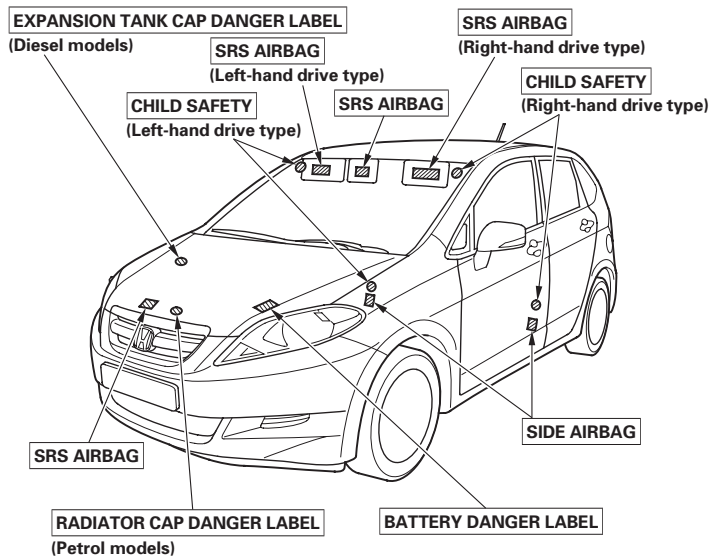





Safety Labels





The label shown below is attached to each front doorjamb.



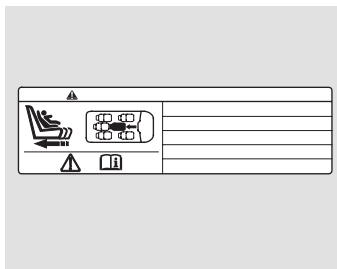

-  • Side Airbag
-  • Safety alert symbol
-  • Follow owner's manual instructions carefully

The label shown below is attached to the centre sunvisor.



-  • Move the front centre seat to the rearmost position before installing the child restraint system (mass group I)
-  • Location of the front centre seat
-   • Follow owner's manual instructions carefully

On diesel models

Symbols   on top of the engine under the engine cover are to remind you to follow the service manual instructions. When replacing the injectors, your authorized Honda dealer should perform this work. Contact your Honda dealer.





06/10/30 16:51:02 32SJD620_071





Instruments and Controls

This section gives information about the controls and displays that contribute to the daily operation of your vehicle. All the essential controls are within easy reach.

Control Locations	70	Temperature Gauge	82	Head Restraints	110
Instrument Panel	72	Fuel Gauge	83	Rear Seat Armrest	111
Instrument Panel Indicators.....	74	Information Display	83	Rear Seat Adjustments	112
Gauges	81	Controls Near the Steering		Reclining the Front Seats	113
Speedometer	81	Wheel	85	Folding the Rear Seats.....	115
Tachometer	81	Windscreen Wipers and		Detachable Anchor.....	117
Outside Temperature		Washers	87	Seat Heaters	119
Indicator.....	82	Turn Signals and Headlights.....	90	Tonneau Cover.....	120
		Daytime Running Lights.....	90	Headlight Adjuster	122
		Front and Rear Fog Lights.....	91	Power Windows	123
		Instrument Panel Brightness	93	Sunroof.....	125
		Rear Window Demister	94	Mirrors.....	126
		Hazard Warning Button.....	94	Parking Brake	128
		Steering Wheel Adjustment	95	Interior Convenience Items.....	130
		Keys and Locks.....	96	Glove Box	131
		Immobilizer System.....	97	Cushion Tray.....	131
		Ignition Switch	98	Beverage Holders.....	132
		Door Locks	99	Driver's Pocket	132
		Power Door Locks.....	99	Centre Pocket	133
		Childproof Door Locks	101	Seat Under Box.....	133
		Tailgate	102	Coat Hooks	134
		Remote Transmitter.....	104	Vanity Mirror	134
		Seats	108	Cigarette Lighter	134
		Front Seat Adjustments.....	108	Ashtray.....	135
		Driver's Seat Manual Height		Accessory Power Socket	135
		Adjustment	110	Interior Lights.....	136





Control Locations

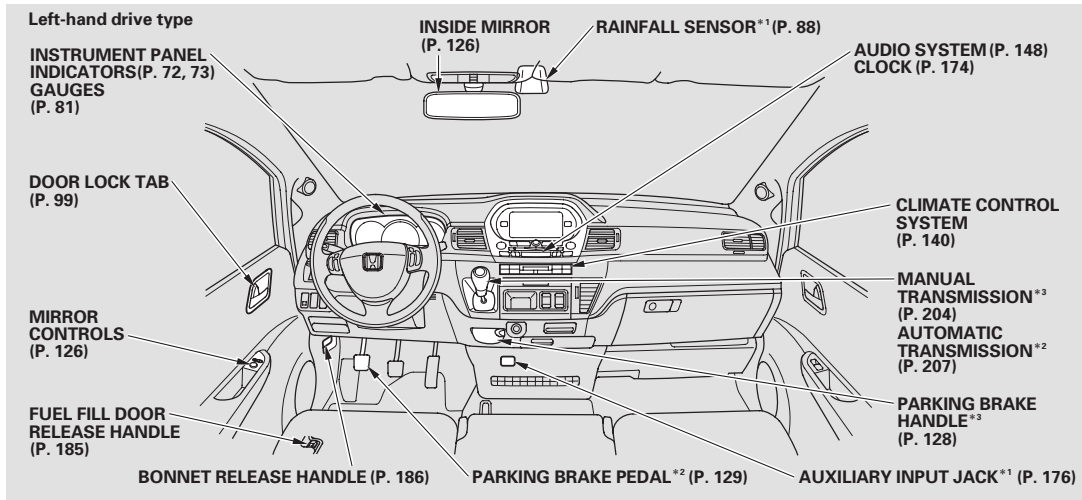

- * 1 : For some types
- * 2 : For automatic transmission models only
- * 3 : For manual transmission models only

70 Instruments and Controls





Control Locations

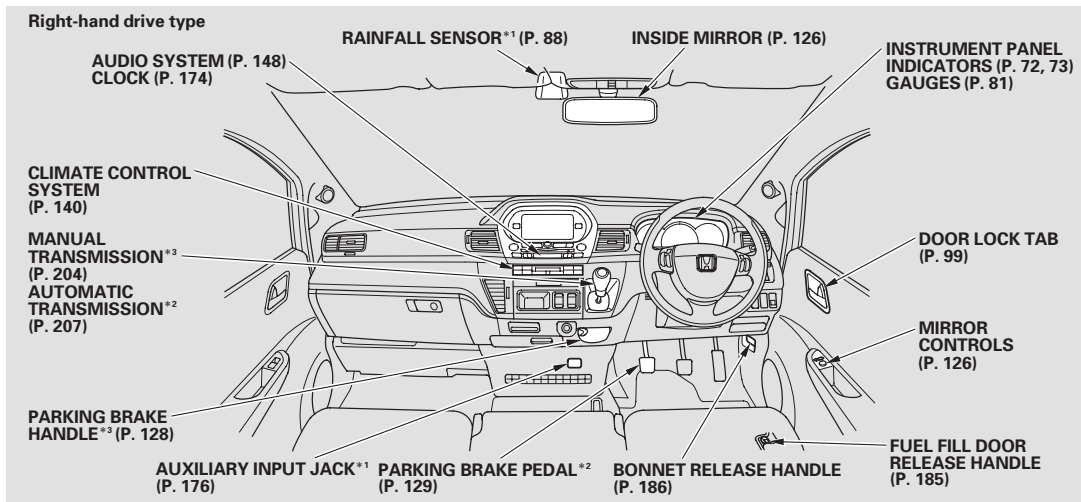

- * 1 : For some types
- * 2 : For automatic transmission models only
- * 3 : For manual transmission models only





Instrument Panel (Petrol models)

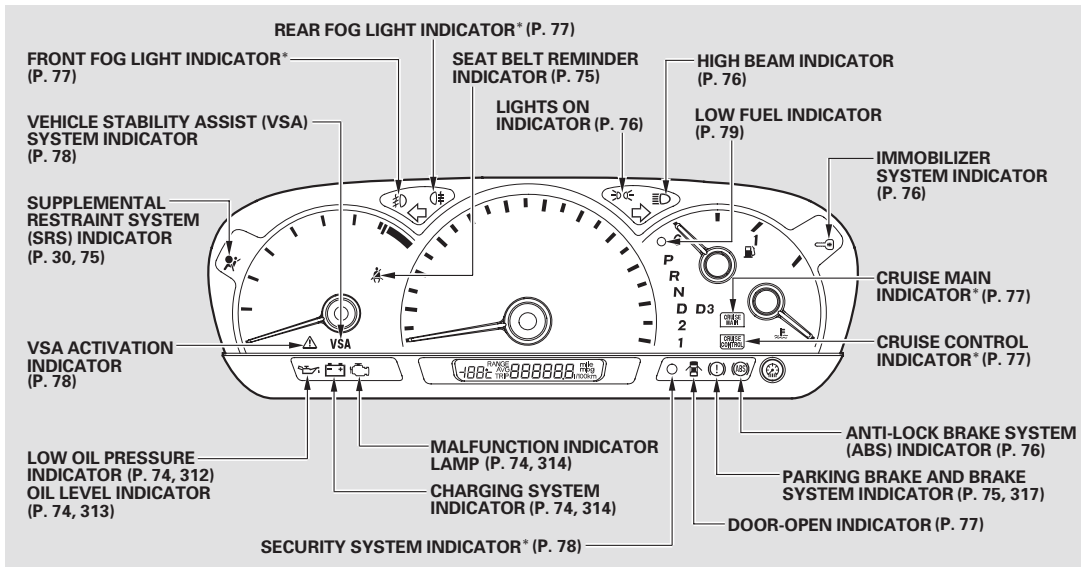

* : For some types



Instrument Panel (Diesel models)

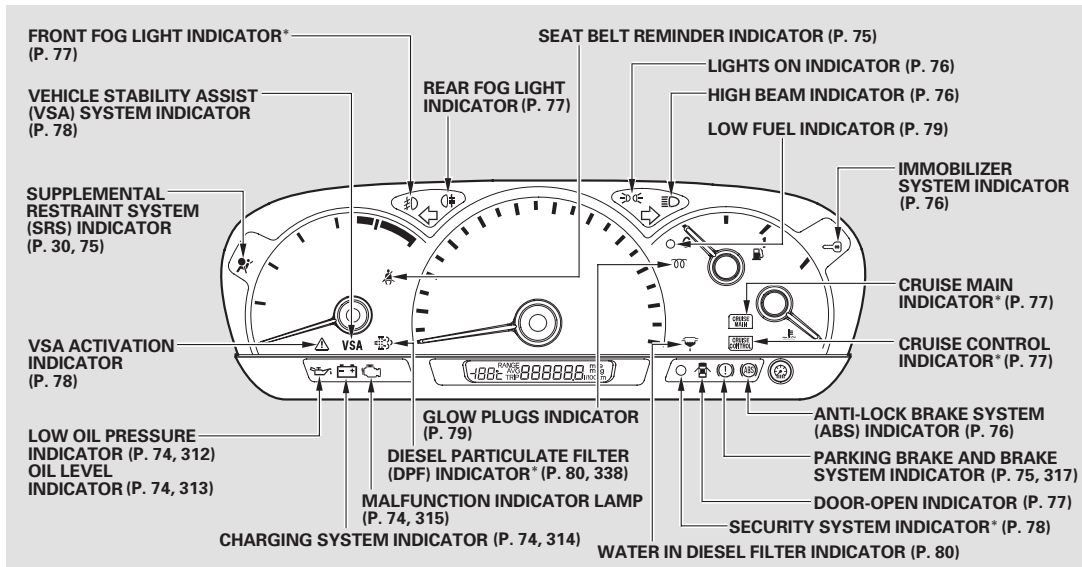

* : For some types



Instrument Panel Indicators

The instrument panel has many indicators to give you important information about your vehicle.



Malfunction Indicator Lamp

See page 314 on petrol models, 315 on diesel models.

On diesel models

This indicator will also come on when you restart the engine after your vehicle has run out of fuel (see page 284).



Low Oil Pressure Indicator (Red)

The engine can be severely damaged if this indicator comes on red and flashes or stays on when the engine is running. For more information, see page 312.



Oil Level Indicator (Amber)

If this indicator comes on amber when the engine is running, the engine oil level is low. You should check the oil level and add engine oil. For more information, see page 313.

This indicator is used for 2 purposes.

1. Amber light — Low oil level as described above.
2. Red light — Low oil pressure. If the indicator comes on red, there may be serious engine damage.

Do not confuse these two different indicator meanings.

NOTICE

If you ignore the oil level indicator and keep driving with this indicator on, you can seriously damage the engine.



Charging System Indicator

If this indicator comes on when the engine is running, the battery is not being charged. For more information, see page 314.





Instrument Panel Indicators



Seat Belt Reminder Indicator

The seat belt system includes an indicator on the instrument panel and a beeper to remind you and your passengers to fasten your seat belts.

If you turn the ignition switch to ON (II) before fastening your seat belt, the beeper sounds several seconds and the indicator flashes. If you do not fasten your seat belt before the beeper stops, the indicator stops flashing but remains on.

If you continue driving without fastening your seat belt, the beeper sounds and the indicator flashes again at regular intervals.



Supplemental Restraint System Indicator

This indicator comes on several seconds when you turn the ignition switch to ON (II). If it comes on at any other time, it indicates a potential problem with your front airbags or automatic seat belt tensioners. This indicator will also alert you to a potential problem with your side airbags or side curtain airbags. For more information, see page 30 .



Parking Brake and Brake System Indicator

This indicator has two functions:

1. It comes on when you turn the ignition switch to the ON (II) position. It is a reminder to check the parking brake. A beeper sounds if you drive with the parking brake not fully released. Driving with the parking brake not fully released can damage the brakes and tyres.
2. If it remains lit after you fully release the parking brake while the engine is running, or if it comes on while driving, there could be a problem with the brake system. For more information, see page 317 .





Instrument Panel Indicators



Immobilizer System Indicator

This indicator comes on for a few seconds when you turn the ignition switch to the ON (II) position. It will go off if you have inserted a properly-coded ignition key. If it is not a properly-coded key, the indicator will blink and the engine will not start (see page 97).

This indicator also blinks several times when you turn the ignition switch from the ON (II) position to the ACCESSORY (I) or LOCK (0) position.



Anti-lock Brake System (ABS) Indicator

This indicator normally comes on for a few seconds when you turn the ignition switch to the ON (II) position, and when the ignition switch is turned to the START (III) position. If it comes on at any other time, there is a problem with the ABS. If this happens, have your vehicle checked at a dealer. With this indicator on, your vehicle still has normal braking ability but no anti-lock function. For more information, see page 215 .



Lights On Indicator

This indicator reminds you that the exterior lights are on. It comes on when the light switch is in either the or position. If you turn the ignition switch to the ACCESSORY (I) or the LOCK (0) position without turning off the light switch, this indicator will remain on. A reminder chime will also sound when you open the driver's door without the key in the ignition switch.



High Beam Indicator

This indicator comes on with the high beam headlights. For more information, see page 90 .





Instrument Panel Indicators



Turn Signal and Hazard Warning Indicators

The left or right turn signal indicator blinks when you signal a lane change or turn. If the indicators do not blink or blink rapidly, it usually means one of the turn signal bulbs is burned out (see pages 260 and 263). Replace the bulb as soon as possible, since other drivers cannot see that you are signaling.

When you press the hazard warning button, both turn signal indicators and all turn signals on the outside of the vehicle flash.



Front Fog Light Indicator (For some types)

This indicator comes on when you turn on the front fog lights. See page 91 for information on operating the front fog lights.



Rear Fog Light Indicator (For some types)

This indicator comes on when you turn on the rear fog light. See page 91 for information on operating the rear fog light.



Door-open Indicator

This indicator comes on if any door or the tailgate is not closed tightly.



Cruise Main Indicator (For some types)

This indicator comes on when you turn on the Cruise Control System by pressing the Master Button (see page 179).



Cruise Control Indicator (For some types)

This indicator comes on when you set the cruise control. See page 179 for information on operating the cruise control.





Instrument Panel Indicators

Security System Indicator (For some types)

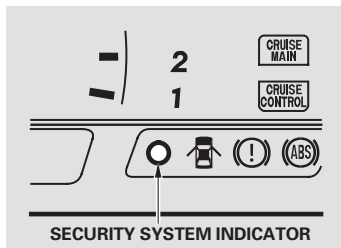

This indicator comes on when the security system is set. See page 177 for more information on the security system.

VSA Vehicle Stability Assist (VSA) System Indicator

This indicator normally comes on for a few seconds when you turn the ignition switch to the ON (II) position.

If it comes on and stays on at any other time, or if it does not come on when you turn the ignition switch to the ON (II) position, there is a problem with the VSA system. Take your vehicle to a dealer to have it checked. Without VSA, your vehicle still has normal driving ability, but will not have VSA traction and stability enhancement. See page 217 for more information on the VSA system.

VSA Activation Indicator

This indicator has three functions:

1. It comes on as a reminder that you have turned off the vehicle stability assist (VSA) system.
2. It flashes when VSA is active (see page 217).
3. It comes on along with the VSA system indicator if there is a problem with the VSA system.

This indicator normally comes on for a few seconds when you turn the ignition switch to the ON (II) position. See page 217 for more information on the VSA system.





Instrument Panel Indicators

Low Fuel Indicator

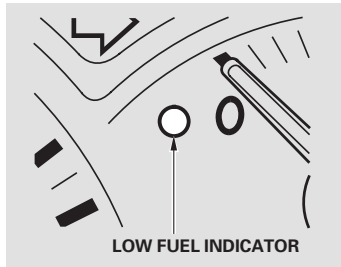

This indicator is located in the fuel gauge. It comes on as a reminder that you must refuel soon.

When the indicator comes on, there is about 8.5 l (2.25 US gal, 1.87 Imp gal) of fuel remaining in the tank before the reading reaches 0. There is a small reserve of fuel remaining in the tank when the reading does reach 0.

On diesel models

Refer to **Priming the Fuel System** on page 284 if your vehicle runs out of fuel.



Glow Plugs Indicator (On diesel models)

This indicator comes on for a few seconds when you turn the ignition switch to the ON (II) position. When the engine is cold, wait for the indicator to go off before starting the engine.

If this indicator blinks while the engine is running, there is a problem in the engine control system. This indicator may also blink when you restart the engine after your vehicle has run out of fuel. For more information, see pages 304 and 316.





Instrument Panel Indicators



Water In Diesel Filter Indicator (On diesel models)

This indicator normally comes on for a few seconds when you turn the ignition switch to the ON (II) position.

If this indicator comes on and stays on while the engine is running, there is a risk of damage to the injection system. Contact your dealer as soon as possible.



Diesel Particulate Filter (DPF) Indicator (On some Diesel models)

If this indicator blinks while the engine is running, the diesel particulate filter (DPF) should be regenerated to remove the accumulated particulate matter (PM).

To regenerate the DPF, when traffic allows, maintain a vehicle speed of at least 60 km/h (37 mph) and continue to drive until the indicator goes out (it may take about 15 minutes). This will increase the exhaust temperature and help to burn and remove the PM from the DPF.

If you ignore the indicator blinking, it stops blinking, then stays on. If this happens, take your vehicle to a Honda dealer as soon as possible to have the DPF system checked. If you ignore this indicator and continue driving, the DPF and your vehicle's emission control systems will be seriously damaged. For more information of the DPF system, see page 338 .





Gauges

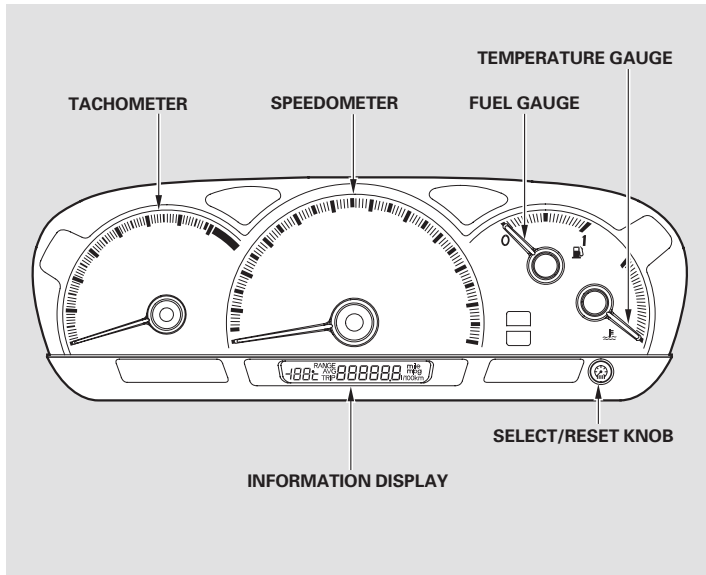

Speedometer

This shows your speed in kilometers per hour (km/h) or miles per hour (mph) and kilometers per hour (km/h) depending on the type.

Tachometer

The tachometer shows the engine speed in revolutions per minute (rpm). To protect the engine from damage, never drive with the tachometer needle in the red zone.





Gauges

Outside Temperature Indicator

This indicator displays the outside temperature in Centigrade.

The temperature sensor is located in the front bumper. Therefore, the temperature reading can be affected by heat reflection from the road surface, engine heat, and the exhaust from the surrounding traffic. This can cause the temperature reading not to be correct when your speed is under 30 km/h (19 mph).

If the outside temperature is incorrectly displayed, you can adjust it up to $\pm 3^{\circ}\text{C}$ warmer or cooler.

NOTE: The temperature must be stabilized before doing this procedure.

Press the Select/Reset knob for 10 seconds. The following sequence will appear for one second each: 0, 1, 2, 3, -3, -2, -1, 0, 1.

When the temperature reaches the desired value, release the Select/Reset knob. You should see the new outside temperature displayed.

In certain weather conditions, temperature readings near freezing (0°C) could mean that ice is forming on the road surface.

Temperature Gauge

This shows the temperature of the engine's coolant. During normal operation, the pointer should rise to about the middle of the gauge. In severe driving conditions, such as very hot weather or a long period of uphill driving, the pointer may rise into the upper half of the gauge. If it reaches the red (hot) mark, pull in safely to the side of the road. Turn to page 308 on petrol models and page 310 on diesel models for instructions and precautions on checking the engine cooling system.





Gauges

Fuel Gauge

This shows how much fuel you have. It may show slightly more or less than the actual amount. The needle returns to the bottom after you turn off the ignition.

NOTICE

On petrol models

Avoid driving with an extremely low fuel level. Running out of fuel could cause the engine to misfire, damaging the catalytic converter.

On diesel models

The malfunction indicator lamp will come on or the glow plugs indicator will blink when you restart the engine after your vehicle has run out of fuel.

Information Display

The information display provides various information; odometer, outside temperature, trip meter, and average fuel mileage. To switch the display, press the Select/Reset knob repeatedly. When you turn the ignition switch to the ON (II) position, what you last selected is shown on the information display.

Odometer

The odometer shows the total number of kilometers or miles your vehicle has been driven.

Trip Meter

The trip meter shows the number of kilometers or miles driven since you last reset it.

To reset a trip meter, display it and then press the Select/Reset knob until the number resets to "0.0".

CONTINUED





Gauges

Average Fuel Mileage

Fuel Mileage Display (mpg or in liters/100 km) depends on models.

The average fuel mileage will be reset when you reset the trip meter, or if the vehicle's battery goes dead or is disconnected.

Range

This shows the estimated distance you can travel on the fuel remaining in the fuel tank. This distance is estimated from the fuel economy you received over the last several kilometres, so it will vary with changes in speed, traffic, etc.





Controls Near the Steering Wheel

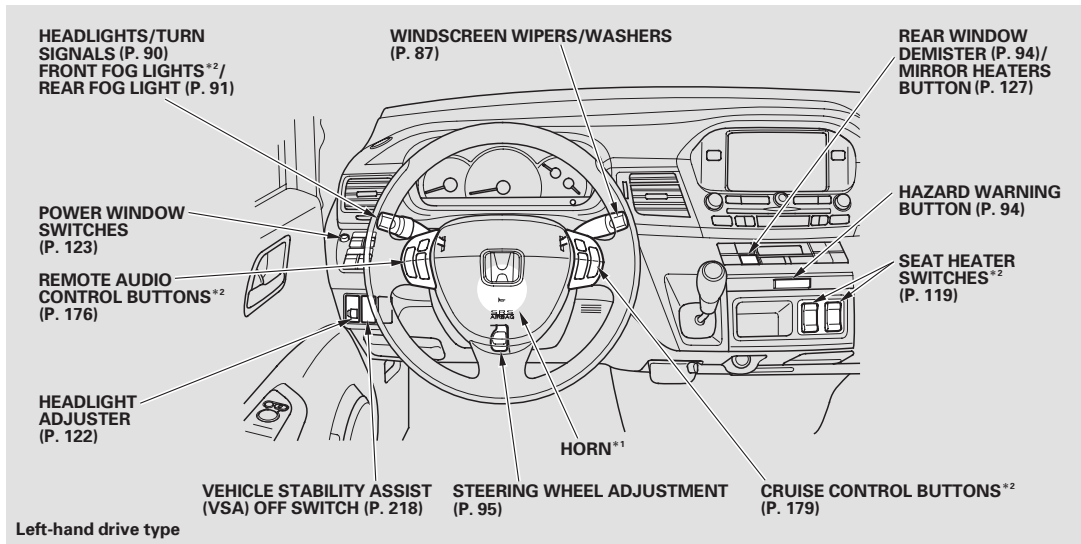

* 1 : To use the horn, press the centre pad of the steering wheel.
 * 2 : For some types

CONTINUED





Controls Near the Steering Wheel

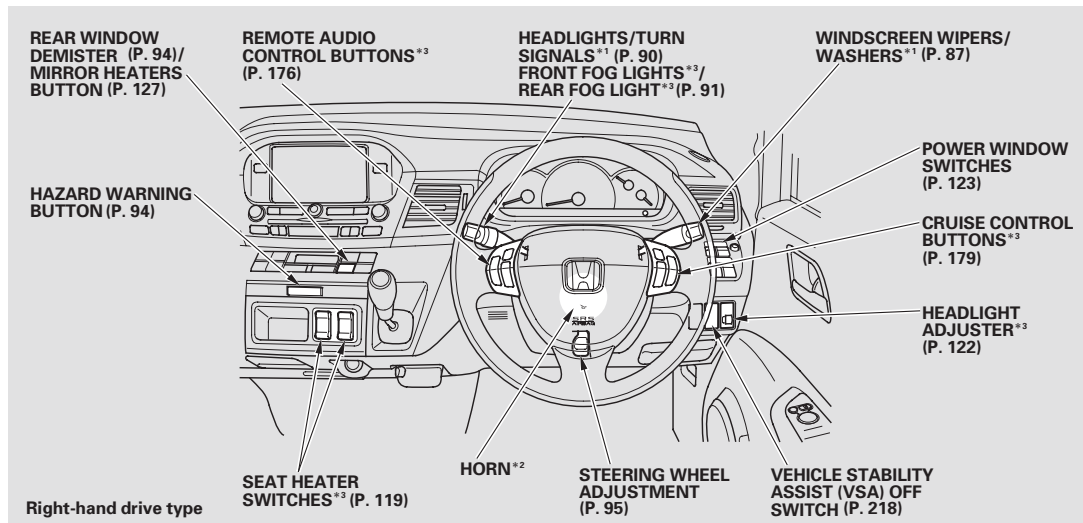

- * 1 : Except for European models, these switches change locations with each other.
- * 2 : To use the horn, press the centre pad of the steering wheel.
- * 3 : For some types

86 Instruments and Controls





Windscreen Wipers and Washers

Windscreen Wipers

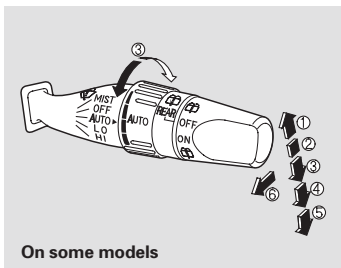
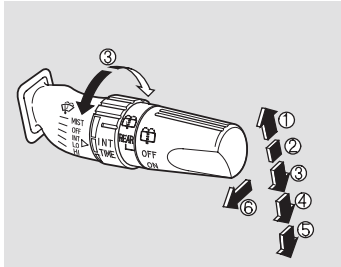

On some models

1. MIST
2. OFF
3. INT – Intermittent
AUTO* – Automatic Intermittent
4. LO – Low speed
5. HI – High speed
6. Windscreen washers

*: On some models

Push the lever up or down to select a position.

MIST – The wipers run at high speed until you release the lever.

OFF – The wipers are not activated.

INT – The wipers operate every few seconds.

On some models
Vary the delay by turning the INT TIME ring.

AUTO – The wipers operate automatically, see page 88 for more information.

LO – The wipers run at low speed.

HI – The wipers run at high speed.

Windscreen Washers – Pull the wiper control lever toward you, and hold it. The washers spray until you release the lever. The wipers run at low speed, then complete one more sweep after you release the lever.

Headlight Washer (If equipped)

When you pull back on the wiper control lever with the headlight switch ON, the headlight washers and windscreen washers work at the same time.
The headlight washers use the same fluid reservoir as the windscreen washers.

CONTINUED





Windscreen Wipers and Washers

Automatic Intermittent Wipers

On some models

The automatic intermittent wiper system senses rainfall and automatically turns on the windscreen wipers. To enable sensing, push the lever down to select AUTO.

When the system senses rainfall, it turns on the windscreen wipers and varies their speed (intermittent, low speed, or high speed) depending on how hard it is raining.

When the wiper lever is in the "LO" (low speed) or "HI" (high speed) position, the windscreen wipers run at that speed. Automatic sensing is disabled.

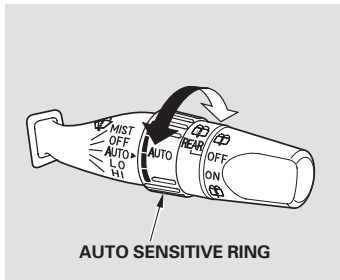

You can adjust the sensitivity of the system by turning the AUTO sensitive ring on the wiper lever.

Turning the ring anticlockwise:
Lowers sensitivity against rainfall.
Turning the ring clockwise:
Heightens sensitivity against rainfall.

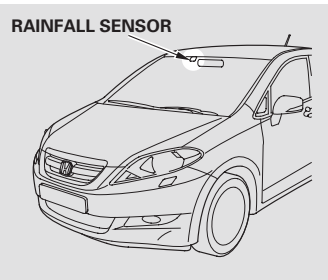

The rainfall sensor is located in the windscreen near the rearview mirror. If the sensor is covered with mud, oil, dust, etc., the wipers may not operate properly or may operate unexpectedly.





Windscreen Wipers and Washers

NOTICE

Do not put the lever in the AUTO position when driving through a car wash. Turn off this system when not in use.

If you try to clean the windscreen around the rainfall sensor using a cloth soaked with water with the ignition switch in the ON (II) position and the wiper switch in the AUTO position, the wiper may operate unexpectedly and you may get injured. Make sure to turn off the wipers before you wash your vehicle.



Rear Window Wiper and Washer

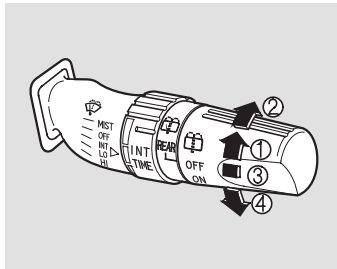

1. Rotate the switch clockwise to turn the rear window wiper ON. It operates intermittently.
2. Hold past ON to turn the rear window wiper on and to spray the rear window washer.
3. OFF

4. Rotate the switch anticlockwise to spray the window washer without activating the wiper.

When you shift the transmission to the reverse position with the front windscreen wipers activated, the rear window wiper operates automatically.

When the front windscreen wiper control lever is positioned as follows:

INT – The rear window wiper operates intermittently.

LO or HI – The rear window wiper operates continuously.





Turn Signals and Headlights

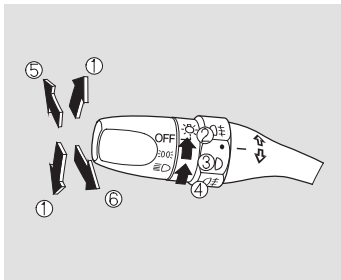



1. Turn signal
2. Off
3. Position lights
4. Headlights on
5. High beams
6. Flash high beams

Turn Signal – Push down or up on the lever to signal a turn. To signal a lane change, push lightly on the lever in the proper direction and hold it. The lever will return to centre when you release it or complete a turn.

Headlights On – Turning the switch on the lever to the “ ” position turns on the position lights, tail-lights, instrument panel lights, and rear licence plate lights.

Turning the switch to the “ ” position turns on the headlights. If you leave the lights on with the key removed from the ignition switch, you will hear a reminder chime when you open the driver’s door.

When the light switch is in the “ ” or the “ ” position, the lights on indicator comes on as a reminder.

High Beams – Push the lever forward until you hear a click. The high beam indicator will come on (see page 76). Pull the lever back to return to the low beams.

To flash the high beams, pull the lever back lightly, then release it. The high beams will stay on as long as you hold the lever back.

Daytime Running Lights (If equipped)

The daytime running lights come on automatically when you turn the ignition switch to the ON (II) position. They go out automatically when the light switch is ON.





Front and Rear Fog Lights

Rear Fog Light (For some types)

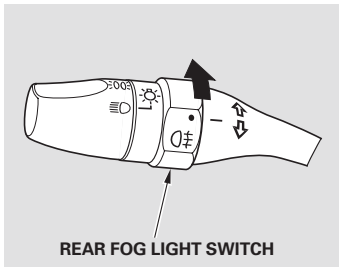

The rear fog light switch is located next to the light control switch. You can use the rear fog light when the headlights are on (the light control switch is in the position).

To operate the rear fog light, turn the switch up from the off () position. The indicator in the instrument panel comes on to indicate that the rear fog light is on.

You can turn off the rear fog light with the headlights on by turning the switch up again.

The rear fog light will go off when you turn the headlights off. To turn the rear fog light on again, you have to turn the rear fog lamp switch again with the headlights on.

Front and Rear Fog Lights (For some types)

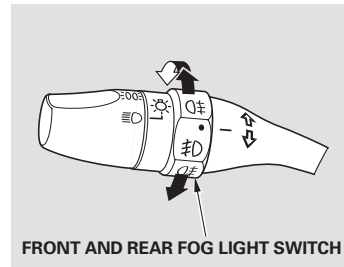



The fog light switch is located next to the light control switch. You can control the front and rear fog lights with this switch when the light control switch is in the or the position.

CONTINUED









Front and Rear Fog Lights

To turn on the rear fog light only, turn the switch down from the off (•) position when the light control switch is in the  position. The  indicator in the instrument panel comes on to indicate that the rear fog light is on.



You can turn off the rear fog light with the headlights on by turning the switch down again.

To operate the front fog lights, turn the switch up from the off (•) position to the  position when the light control switch is in the  or the  position. The  indicator comes on as a reminder. To turn the rear fog light on with the front fog lights, turn the switch one position up from the  position.

You can turn off the rear fog light only by turning the switch up again.

The front and rear fog lights will go off when you turn the headlights off without turning the fog light switch off.

When you turn the headlights on again, the front fog lights will also turn on. To turn the fog lights completely off, turn the fog light switch down to the off (•) position.

To turn the rear fog light on again, you have to turn the fog light switch to the  position with the headlights ( position) or the front fog lights on.





Instrument Panel Brightness

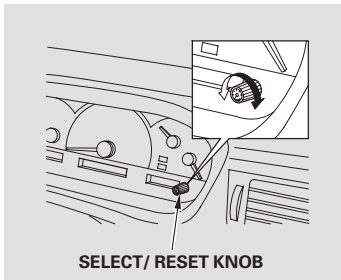

The knob on the instrument panel controls the brightness of the instrument panel lights. Turn the knob to adjust the brightness.

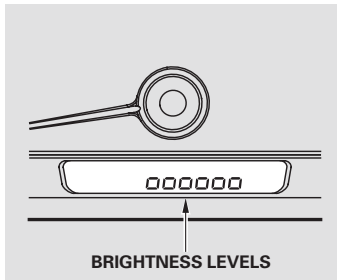

The brightness can be shown within the six brightness levels on the information display. When you turn the knob, the information display changes to circles that show you the current level. You will hear a beep when you reach the maximum or minimum brightness. The display returns to the odometer/trip meter values 5 seconds after you stop adjusting the knob.

The instrument panel brightness dims when you turn the light control switch to the  or  position to reduce glare at night. To cancel it, turn the Select/Reset knob fully to the right until you hear a beep.

You can adjust the brightness to the desired level with the headlight switch off, and also with the headlight switch on. Both settings will remain at those levels until you change them.





Rear Window Demister, Hazard Warning Button

Rear Window Demister



The rear window demister will clear fog, frost, and thin ice from the window. Turn the ignition switch to the ON (II) position. Push the demister button to turn it on and off. The indicator in the button comes on to show the demister is on.

The demister will shut off when you turn the ignition switch to the ACCESSORY (I) position. You have to turn the demister on again when you restart the vehicle.

Make sure the rear window is clear and you have good visibility before starting to drive.

The demister wire on the inside of the rear window can be accidentally damaged. When cleaning the glass, always wipe side-to-side.

The power mirror heaters turn on or off too, by pushing the demister button (see page 127).

Hazard Warning Button

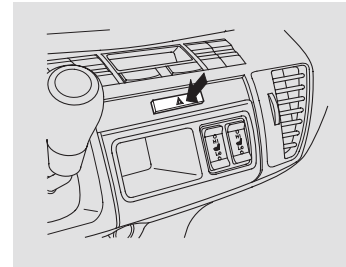

Push the button next to the shift lever to turn on the hazard warning lights (four-way flashers). This causes all outside turn signals and both turn indicators in the instrument panel to flash. Use these lights to give a warning to other road users that your vehicle is causing a hazard.





Steering Wheel Adjustment

Make any steering wheel adjustment before you start driving.

⚠ WARNING

Adjusting the steering wheel position while driving may cause you to lose control of the vehicle and be seriously injured in a crash.

Adjust the steering wheel only when the vehicle is stopped.

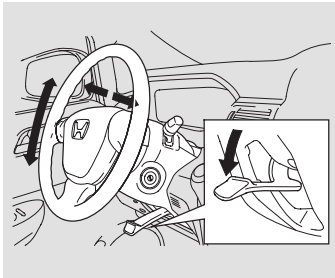

1. Push the lever under the steering column all the way down.

2. Move the steering wheel up or down, and in or out, so it points toward your chest, not toward your face. Make sure you can see the instrument panel gauges and indicators.

3. Push the lever up to lock the steering wheel in position.

4. Make sure you have securely locked the steering wheel in place by trying to move it up, down, in, and out.





Keys and Locks

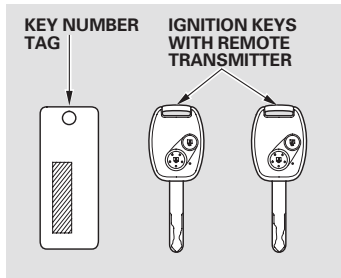

Two ignition keys come with your vehicle. You should keep one of them in a safe place, away from the vehicle, as a spare. They fit all the locks on your vehicle.

You should have received a key number tag with your keys. You will need this key number if you ever have to get a lost key replaced. Use only Honda-approved key blanks.

Remote Transmitter
Your two ignition keys are also fitted with remote transmitters; see page 104 for an explanation of the operation.

These keys contain electronic circuits that are activated by the immobilizer system. They will not work to start the engine if the circuits are damaged.

- Protect the keys from direct sunlight, high temperature, and high humidity.
- Do not drop the keys or set heavy objects on them.
- Keep the keys away from liquids. If they get wet, dry them immediately with a soft cloth.





Immobilizer System

The immobilizer system protects your vehicle from theft. If an improperly-coded key (or other device) is used, the engine will not start.

When you turn the ignition switch to the ON (II) position, the immobilizer system indicator should come on for a few seconds, then go off. If the indicator starts to blink, it means the system does not recognize the coding of the key. Turn the ignition switch to the LOCK (0) position, remove the key, reinsert it, and turn the ignition switch to the ON (II) position again.

The system may not recognize your key's coding if another immobilizer key or other metal object (i.e. key fob) is near the ignition switch when you insert the key.

If the system repeatedly does not recognize the coding of your key, contact your dealer.

This indicator also blinks several times when you turn the ignition switch from the ON (II) position to the ACCESSORY (I) or LOCK (0) position.

Do not attempt to alter this system or add other devices to it. Electrical problems could result that may make your vehicle undrivable.

If you have lost your key and you cannot start the engine, contact your dealer.

(EU models)

EC Directives

This immobilizer system complies with the R & TTE (Radio equipment and Telecommunications Terminal Equipment and the mutual recognition of their conformity) Directives.

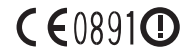



Ignition Switch

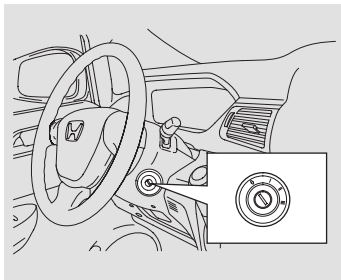

The ignition switch has four positions: LOCK (0), ACCESSORY (I), ON (II), and START (III).

LOCK (0) – You can insert or remove the key only in this position. To turn the key, push it in slightly. If your vehicle has an automatic transmission, the shift lever must also be in park.

If the front wheels are turned, the anti-theft lock may make it difficult to turn the key. Firmly turn the steering wheel to the left or right as you turn the key.

ACCESSORY (I) – You can operate the audio system and the cigarette lighter in this position.

ON (II) – This is the normal key position when driving. Several of the indicators on the instrument panel come on as a test when you turn the ignition switch from the ACCESSORY (I) to the ON (II) position.

On some types, the headlights come on automatically in this position (see page 90).

START (III) – Use this position only to start the engine. The switch returns to the ON (II) position when you let go of the key.

You will hear a reminder beeper if you leave the key in the ignition switch in the LOCK (0) or the ACCESSORY (I) position and open the driver's door. Remove the key to turn off the beeper.

On vehicles with manual transmission

▲ WARNING

Removing the key from the ignition switch while driving locks the steering. This can cause you to lose control of the vehicle.

Remove the key from the ignition switch only when parked.

If your vehicle has an automatic transmission, the shift lever must be in Park before you can remove the key from the ignition switch.





Door Locks

Power Door Locks

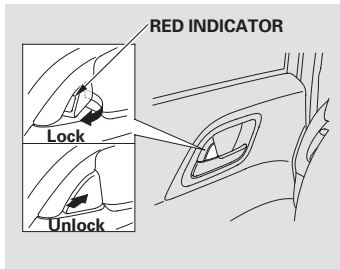

Each door has a lock tab next to the inside door handle. When you pull out or push in the lock tab on the driver's door, all doors and the tailgate lock or unlock. The lock tab on each passenger's door only locks and unlocks that door.

When the door is unlocked, the red mark on the lock tab is shown.

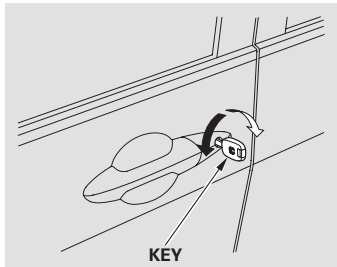

All doors and the tailgate lock or unlock when you use the key to lock or unlock the driver's door.

To lock any passenger's door when getting out of the vehicle, pull the lock tab out and close the door. To lock the driver's door, remove the key from the ignition switch, pull the outside door handle and pull the lock tab out. Release the handle, then close the door.

When you lock the doors and the tailgate with the key or the remote transmitter, all outside turn signals and both indicators in the instrument panel flash three times to verify the doors and the tailgate are locked and the security system (if equipped) has set. When you unlock them, these lights flash once.

CONTINUED





Door Locks

On vehicles with security system

The security system activates after you lock the doors and the tailgate with the lock tab on the driver's door while pulling the outside door handle, and then close the door (see page 177).

Lockout Prevention

If you forget and leave the key in the ignition switch, lockout prevention will not allow you to lock the driver's door. If you try to lock an open driver's door by pulling the lock tab out with the outside handle pulled, the tabs on all doors pop out when you close the driver's door.

Super Locking *(For some types)*

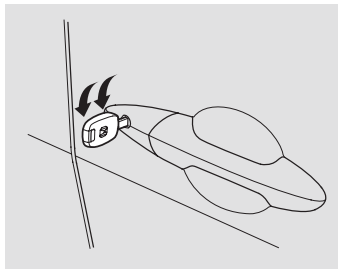

The super locking helps to protect your vehicle and valuables from theft. To set the super locking, turn the key towards the front of the vehicle twice within 5 seconds.

The super locking will not set if any door or the tailgate is not fully closed. It will be set even if the bonnet, any window or the sunroof is open.

With the super locking set, the lock tabs on all doors are disabled.

You can also set the super locking with the remote transmitter. To set it, push the LOCK button twice within 5 seconds (see page 105).

To cancel the super locking, unlock the driver's door with the key or the remote transmitter.





Door Locks

⚠ WARNING

If there are persons inside the vehicle with the super locking set, they cannot unlock the door from the inside.

Make sure there is no person inside the vehicle before setting the super locking.

On vehicles with ultrasonic sensor
Only the remote transmitter can reset the security system. Unlocking the driver's door with the key activates the alarm.

If you set the super locking with the windows open, the ultrasonic sensor may activate the alarm unexpectedly when the system senses strong vibrations on the vehicle or loud sound.

Childproof Door Locks

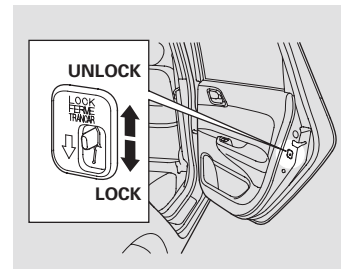

The childproof door locks are designed to prevent children seated in the rear from accidentally opening the rear doors. Each rear door has a lock lever near the edge. With the lever in the LOCK position (lever is down), the door cannot be opened from the inside regardless of the position of the lock tab. To open the door, push the lock tab in and use the outside door handle.





Tailgate

The tailgate will lock or unlock when you lock or unlock the driver's door by using the key, the remote transmitter, or the lock tab on the driver's door.

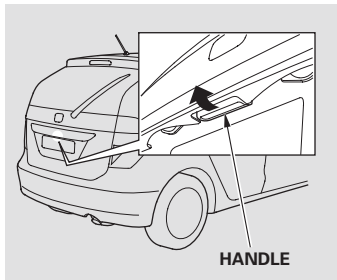

Keep the tailgate closed at all times while driving to avoid damaging the tailgate and to prevent exhaust gas from getting into the interior. See **Carbon Monoxide Hazard** on page 65.

To open the tailgate, pull the handle, then lift up. To close it, press down on the back edge.





Tailgate

Unlocking the Tailgate

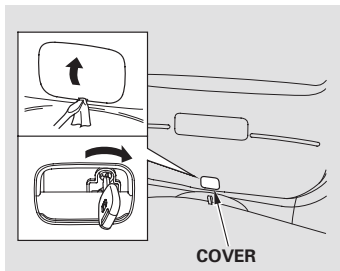

If the power door lock system cannot unlock the tailgate, unlock it manually.

1. Use a small flat-tipped screwdriver to remove the cover on the tailgate lining.
2. Insert the ignition key to the cylinder, turn the key right to unlock the tailgate.

If you need to unlock the tailgate manually, it means there is a problem with the tailgate. Have the vehicle checked by your dealer.





Remote Transmitter

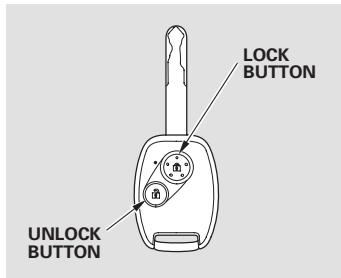

LOCK — Press this button to lock all doors and the tailgate. When you push the LOCK button, all outside turn signals and both indicators in the instrument panel flash three times to verify the doors and the tailgate are locked and the security system (if equipped) has set. You cannot lock the doors and the tailgate if any door or the tailgate is not fully closed or the key is in the ignition switch.

UNLOCK — Press this button to unlock all doors and the tailgate. When you push the UNLOCK button, all outside turn signals, and both indicators in the instrument panel flash once.

The ceiling light (if the ceiling light switch is in the door activated position) will come on when you press the UNLOCK button. If you do not open any door or the tailgate, the light will fade out in about 30 seconds. If you relock the doors and the tailgate with the remote transmitter before 30 seconds have elapsed, the light will go off immediately.

If you do not open any door or the tailgate within 30 seconds, the doors and the tailgate automatically relock and the security system (if equipped) sets.

You cannot unlock the doors and the tailgate if the key is in the ignition switch.





Remote Transmitter

Super Locking *(For some types)*

The super locking helps to protect your vehicle and valuables from theft. To set the super locking, push the LOCK button twice within 5 seconds.

The super locking will not set if any door or the tailgate is not fully closed. It will be set even if the bonnet, any window or the sunroof is open.

To cancel the super locking, push the UNLOCK button on the remote transmitter, or unlock the driver's door with the key.

See page 100 for information on the super locking.

⚠ WARNING

If there are persons inside the vehicle with the super locking set, they cannot unlock the door from the inside.

Make sure there is no person inside the vehicle before setting the super locking.

Replacing the Battery

When the remote transmitter's battery begins to get weak, it may take several pushes on the button to lock or unlock the doors and tailgate, and the LED will not light. Replace the battery as soon as possible.

Battery type: CR1616

CONTINUED





Remote Transmitter

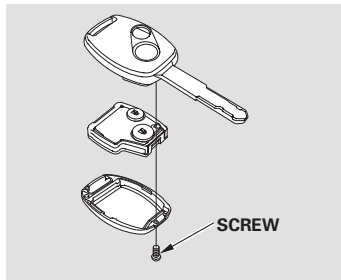

To replace the battery:

1. Remove the screw at the base of the transmitter with a small Phillips-head screwdriver.
2. Separate the transmitter by prying its middle seam with your fingernail.

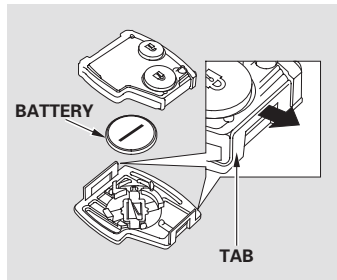

3. Inside the transmitter, separate the inner cover from the keypad by releasing the two tabs on the cover.

4. Remove the old battery from the back of the inner cover, and note the polarity. Make sure the polarity of the new battery is the same (+ side facing down), then insert it into the back of the cover.

NOTICE

An improperly disposed of battery can hurt the environment. Always confirm local regulations for battery disposal.

5. Install the parts in reverse order.





Remote Transmitter

(EU models)

EC Directives

This keyless entry system complies with the R & TTE (Radio equipment and Telecommunications Terminal Equipment and the mutual recognition of their conformity) Directives.

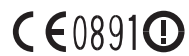

Remote Transmitter Care

- Avoid dropping or throwing the transmitter.
- Protect the transmitter from extreme temperature.
- Do not immerse the transmitter in any liquid.
- If you lose a transmitter, the replacement needs to be reprogrammed by your dealer.





Seats

Front Seat Adjustments

See pages 14 – 16 for important safety information and warnings about how to properly position the seats and seat-backs.

Make all seat adjustments before you start driving.

Front Outer Seat

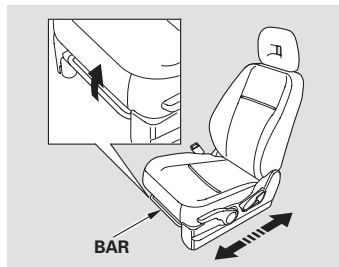

To adjust the seat forward or backward, pull up on the bar under the seat cushion's front edge. Move the seat to the desired position, and release the bar. Try to move the seat to make sure it is locked in position.

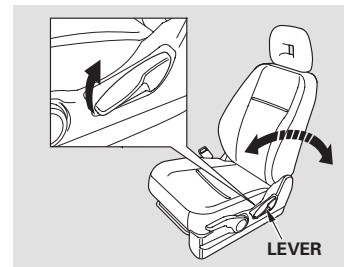

To change the seat-back angle, pull up on the lever on the outside of the seat cushion.

Once a seat is adjusted correctly, rock it back and forth to make sure it is locked in position.

108 Instruments and Controls





Seats

Front Centre Seat

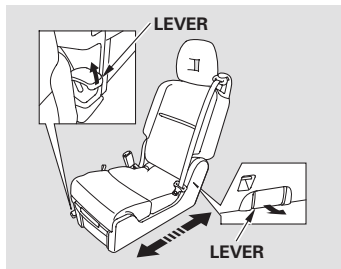

To adjust the seat forward or backward, pull up on the lever under the right side of the seat cushion's front edge. Move the seat to the desired position, and release the lever. Try to move the seat to make sure it is locked in position.

It can be also moved by pulling the lever on the bottom of the seat-back while you are sitting in the rear seat. When the front centre seat is occupied, do not operate it from the rear seat side.

If you install the child restraint system (mass group I) to the front centre seat, position the rear centre seat at least one position back. Then, position the front centre seat to its rearmost position.

The front centre seat cannot be moved to the rearmost position with the rear centre seat folded down.

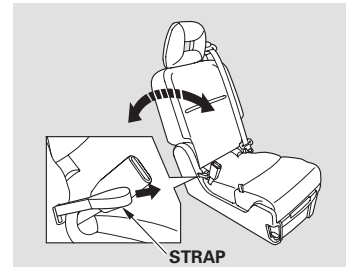

To change the angle of the seat-back, pull the strap on the right side of the seat bottom. Move the seat-back to the desired position and release the strap. Let the seat-back latch into the new position.





Seats

Driver's Seat Manual Height Adjustment

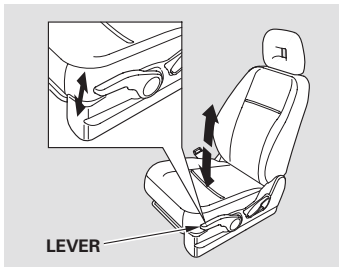

The height of your driver's seat is adjustable. To raise the seat, repeatedly pull up the lever on the outside of the seat cushion. To lower the seat, push the lever down repeatedly.

Make sure to pull the lever upward or downward to its full range. Make all adjustments before you start driving.

Head Restraints

See page 16 for important safety information and a warning about how to properly position the head restraints.

Your vehicle is equipped with head restraints in all seating positions to help protect you and your passengers from whiplash and other injuries.

They are most effective when you adjust them so the back of the occupant's head rests against the centre of the restraint.

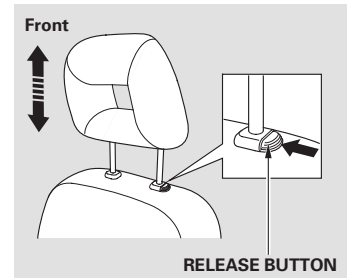

The head restraints adjust for height. You need both hands to adjust a restraint. Do not attempt to adjust it while driving. To raise it, pull upward. To lower the restraint, push the release button sideways, and push the restraint down.

110 Instruments and Controls





Seats

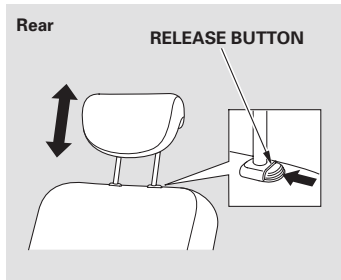

When you use the rear seat, adjust the head restraint to the highest position by pulling it upward. You cannot use this head restraint in the lower position.

To remove a head restraint for folding down the rear seat, cleaning or repair, pull it up as far as it will go. Push the release button and pull the restraint out of the seat-back.

⚠ WARNING

Always replace the rear head restraints when the seat-backs are returned to upright position.

Rear Seat Armrest (For some types)

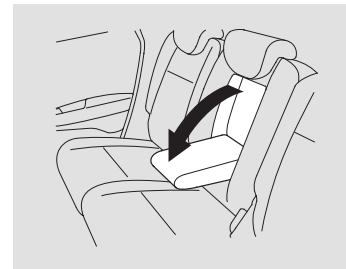

The rear seat armrest is in the centre of the rear seat. Pivot it down to use it.





Seats

Rear Seat Adjustments

See pages 14 – 16 for important safety information and warnings about how to properly position the seats and seat-backs.

Make all seat adjustments before you start driving.



To adjust the rear centre seat forward or backward, pull up on the lever under the seat cushion's front edge. Move the seat to the desired position, and release the lever. Try to move the seat to make sure it is locked in position.

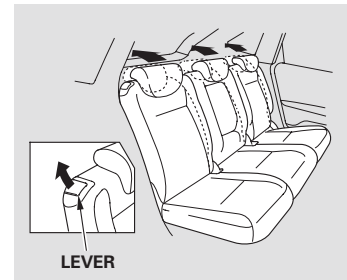

The angle of each rear seat-back can be adjusted separately. To change the seat-back angle of the rear seat-back, pull up on the release lever on the top of the seat-back. Move the seat-back to the desired position, then release the lever. Make sure the seat-back latches in the new position.

112 Instruments and Controls





Seats

Reclining the Front Seats

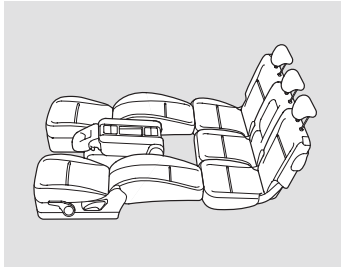

You can recline the seat-backs on the front seats to a fully flat position so they are level with the rear seat cushions, making a large cushioned area. To do this:

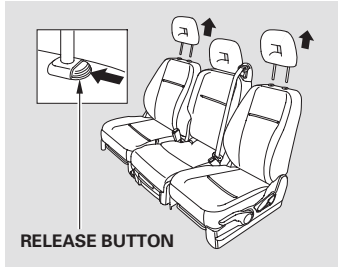

1. Remove the head restraints by pushing the release buttons and pulling the restraints out (see page 110).

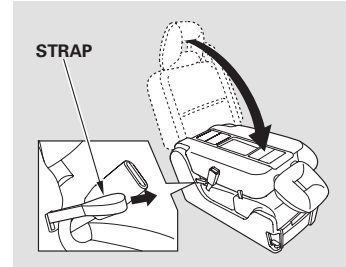

2. Pull the strap on the right side of the seat bottom and fold the front centre seat-back forward.

When you fold the front centre seat-back forward, adjust the head restraint to the lowest position.

The beverage holders must be folded away when they are not in use.

CONTINUED





Seats

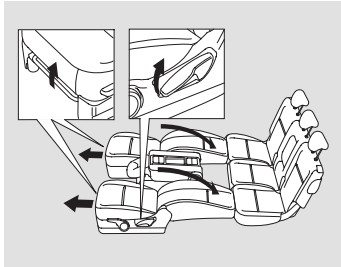

3. Adjust the front outer seats forward as far as possible. Pull up the seat-back angle adjustment lever and pivot the seat-back backward until it is level with the rear seat cushion.

Reverse this procedure to return the front seats to the upright position. Make sure you install the head restraints and the seats are locked securely before driving.

When you return the seat-back to its upright position, hold the seat-back to keep it from going up too quickly.

⚠ WARNING

Make sure the seat-backs are latched securely before driving.





Seats

Folding the Rear Seats

Each rear seat-back can be folded down separately to give more luggage room. With either of the outer seat-backs folded, you can still carry a passenger in the rear centre seat. With the centre seat-back folded, either rear outer seating position can be used.

Remove any items from the seat before folding down the seat-back.

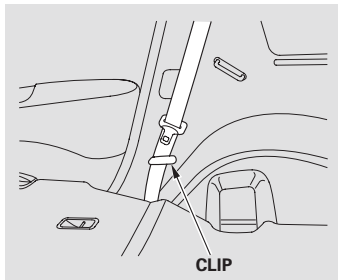

Make sure the outer shoulder belts are positioned on each clip whenever the rear outer seat is folded.

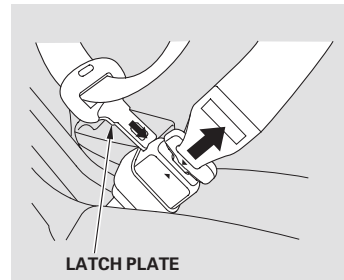

When you are folding the rear centre seat, use the latch plate to release the centre seat belt from the detachable anchor (see page 117). Allow the seat belt to retract into the holder on the ceiling and store the buckles in it.

Make sure the rear seat armrest is stored.

CONTINUED

Instruments and Controls 115





Seats

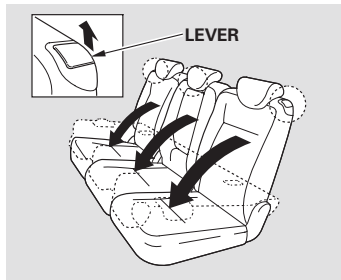

To fold down the rear seat:

1. Before folding down the rear seat-back, move the front centre seat to the forward most position (see page 109).
2. Lower the rear head restraints to their lowest position.

3. Pull the release lever up to unlatch the seat-back. Move the seat belt out of the way and fold the seat-back down holding it with your hands.

The rear centre seat cannot be folded unless the front centre seat is in the foremost position.

Reverse this procedure to return the seat to the upright position. Make sure the seat is locked securely before driving.

⚠ WARNING

Make sure the seat-backs are latched securely before driving.

Make sure all rear shoulder belts are positioned in front of the rear seat-backs and the seat belt buckles are on the seat cushion whenever the seat-back is in its upright position.

In the rear centre seating position, be sure the detachable anchor is latched securely (see page 117).



116 Instruments and Controls





Seats

Detachable Anchor

The seat belt in the rear centre seat is equipped with a detachable anchor. This allows the centre seat belt to be unlatched when the rear centre seat is folded.

When the rear seat is returned to the upright position, the detachable anchor should be latched back properly.

⚠ WARNING

Using a seat belt with the detachable anchor unlatched increases the chance of serious injury or death in a crash.

Before using the seat belt, make sure the detachable anchor is correctly latched.

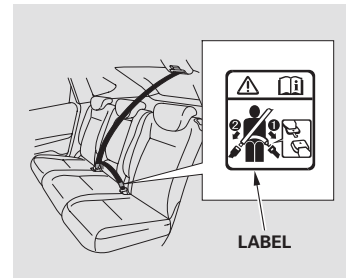

The seat belt with a detachable anchor has a label as shown in the illustration above.

CONTINUED

Instruments and Controls 117





Seats

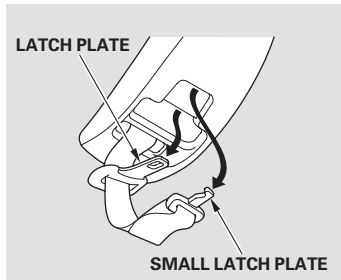

Pull out the small latch plate and the latch plate from each holding slot in the ceiling, and pull out the seat belt to extend it.

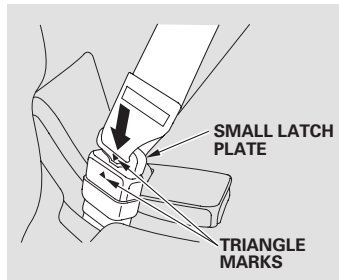

Line up the triangle marks on the small latch plate and anchor buckle when reattaching the belt and buckle.

Tug on the seat belt to verify that the detachable anchor is securely latched. Make sure the seat belt is not twisted.

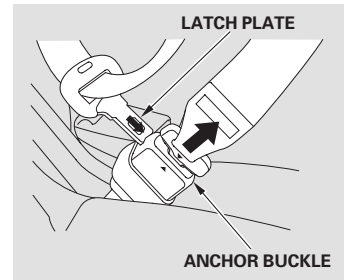

To unlatch the detachable anchor, insert the latch plate into the slot on the side of the anchor buckle. Store the detachable anchor and seat belt latch plates in the retractor housing.



118 Instruments and Controls





Seat Heaters (For some types)

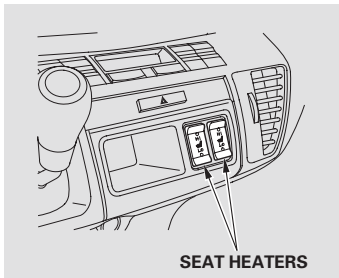

Both front outer seats are equipped with seat heaters. The ignition switch must be in the ON (II) position to use them. Push the top of the switch, HI, to rapidly heat up the seat. After the seat reaches a comfortable temperature, select LO by pushing the bottom of the switch. This will keep the seat warm.

In the HI setting, the heater turns off when the seat gets warm, and turns back on after the seat's temperature drops.

In the LO setting, the heater runs continuously. It does not cycle with temperature changes.

Follow these precautions whenever you use the seat heaters:

- Use the HI setting only to heat the seats quickly, because it draws large amounts of current from the battery.
- Do not use the seat heaters, even on the LO setting, if the engine is left idling for an extended period. This can weaken the battery, causing hard starting.





Tonneau Cover (For some types)

You can use the tonneau cover to conceal your parcels and protect them from direct sunlight.

Do not store parcels on the tonneau cover. The tonneau cover may break if weight is placed on it.

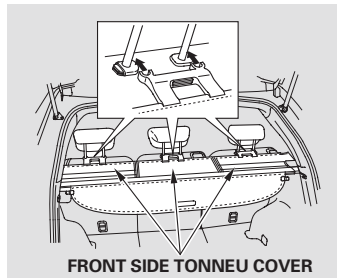

The tonneau cover can be extended forward and rearward separately.

The front side tonneau cover can be used separately.

To extend left, centre or right tonneau cover, pull the clips of the tonneau cover out of its housing, and hook the clips on the legs of the rear head restraint.

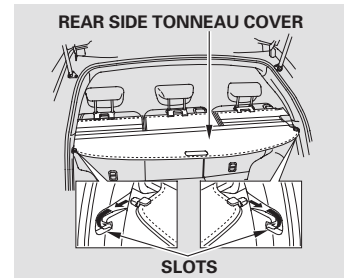

To extend the rear side tonneau cover, pull the cover's leading edge out of its housing and set the mounting rods in the slots.

To retract the cover, release the rods from the slots and guide the cover to roll back fully into its housing.





Tonneau Cover (For some types)

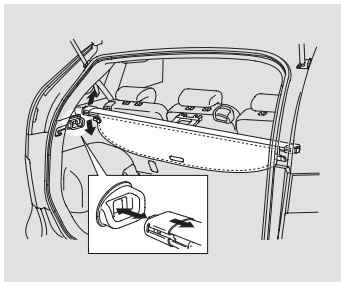

To remove the tonneau cover, release each side of the cover by pushing one end of the unit toward the other end and lifting it up.

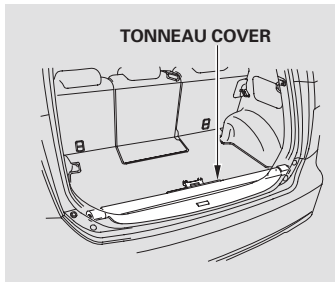

While the tonneau cover is not in use, place the cover as shown in the illustration.

To use the tonneau cover, place one end into the holder and push the other end inward and push down that end into its holder until it locks into place.

Make sure it is securely latched so it will not come loose while you are driving.





Headlight Adjuster (For some types)

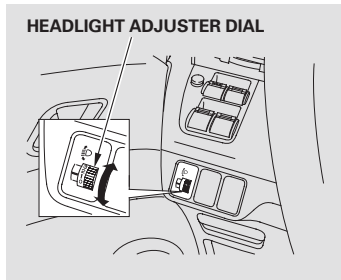

The vertical angle of the headlights can be adjusted according to the number of persons and the loading weight in the luggage area.

Turn the ignition switch to the ON (II) position. Turn the adjusting dial to select an appropriate angle of the headlights.

0: A driver or a driver and passenger in the front seat.

1: Two persons in front and three persons in rear seats or six persons in the front and rear seats.

2: Six persons in the front and rear seats and luggage in the luggage area, within the limits of maximum permissible axle weight and maximum permissible vehicle weight.

3: A driver and luggage in the luggage area, within the limits of maximum permissible axle weight and maximum permissible vehicle weight.

On vehicles with headlights bulbs of high voltage discharge tube

Your vehicle is equipped with an automatic headlight adjusting system that senses changes in the vehicle posture due to riding and loading conditions of the passengers and their luggage and adjusts the vertical angle of the headlights automatically.





Power Windows

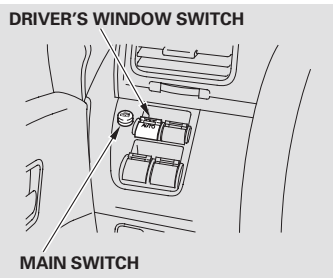

Turn the ignition switch to the ON (II) position to raise or lower any window. To open the window, push the switch down and hold it. Release the switch when you want to stop the window. To close the window, pull back on the switch and hold it.

The windows will operate for up to 10 minutes after you turn off the ignition switch. Opening either front door cancels this function.

⚠ WARNING

Closing a power window on someone's hands or fingers can cause serious injury.

Make sure your passengers are away from the windows before closing them.

WARNING: *Always take the ignition key with you whenever you leave the vehicle alone (with other occupants).*

When you push the MAIN switch in, the switch is off, and the passenger windows cannot be raised or lowered. To cancel this feature, push on the switch again to get it to pop out. Keep the MAIN switch off when you have children in the vehicle so they do not injure themselves by operating the windows unintentionally.

CONTINUED





Power Windows

AUTO – To open or close the driver's window, push or pull the window switch firmly down or up to the second detent, and release it. The window will automatically go down or up all the way. To stop the window, pull or push the window switch briefly.

To open or close the window partially, push down or pull back on the window switch lightly to the first detent, and hold it. The window will stop when you release the switch.

AUTO REVERSE – If the driver's window senses any obstacle while it is closing automatically, it will reverse direction, and then stop. To close the window, remove the obstacle, then use the window switch again.

Auto reverse stops sensing when the window is almost closed. You should always check that all passengers and objects are away from the window before closing it.





Sunroof (For some types)

On vehicles without navigation system

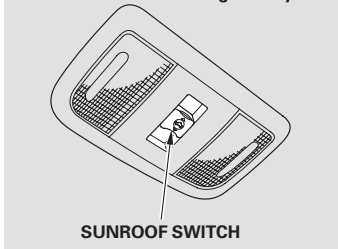

SUNROOF SWITCH

The sunroof can be tilted up in the back for ventilation, or it can be slid back into the roof. Use the switch on the front ceiling to operate the sunroof. You must turn the ignition switch to the ON (II) position to operate the sunroof.

To tilt up the back of the sunroof, straight up on the centre of the switch. To close the sunroof, push the switch forward and hold it. To open the sunroof, pull the switch backward and hold it.

⚠ WARNING

Opening or closing the sunroof on someone's hands or fingers can cause serious injury.

Make sure all hands and fingers are clear of the sunroof before opening or closing it.

NOTICE

If you try to open the sunroof in below-freezing temperatures, or when it is covered with snow or ice, you can damage the sunroof panel or motor.

WARNING: Always take the ignition key with you whenever you leave the vehicle alone (with other occupants).

WARNING: Extending the head, arms or other parts of the body through the sunroof while the vehicle is moving can cause serious injury or death.





Mirrors

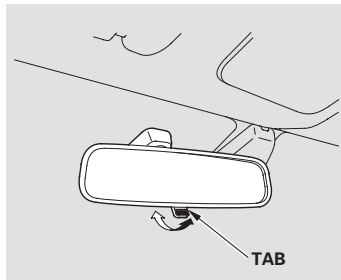

Keep the inside and outside mirrors clean and adjusted for best visibility. Be sure to adjust the mirrors before you start driving.

The inside mirror has day and night positions. The night position reduces glare from headlights behind you. Flip the tab on the bottom edge of the mirror to select the day or night position.

Adjusting the Power Mirrors

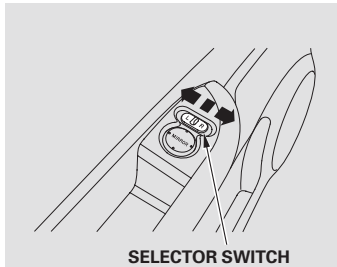

1. Turn the ignition switch to the ON (II) position.
2. Move the selector switch to L (left side) or R (right side).

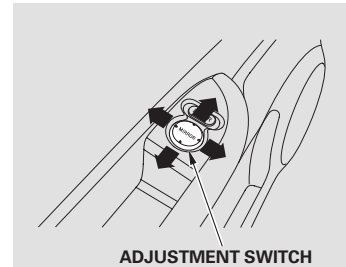

3. Push the appropriate edge of the adjustment switch to move the mirror right, left, up, or down.
4. When you finish, move the selector switch to the centre (off) position. This turns off the adjustment switch to keep your settings.





Mirrors

Power Mirror Heaters

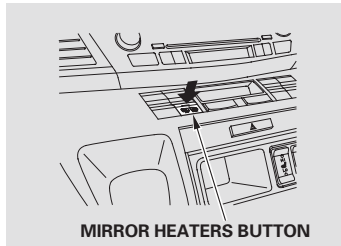

The outside mirrors are heated to remove fog and frost. With the ignition switch in the ON (II) position, turn on the heaters by pressing the button. The rear window demister simultaneously functions, too, by pressing this button. The indicator in the button comes on as a reminder. Press the button again to turn the heaters off. It also stops the rear window demister.

Folding Door Mirrors (For some types)

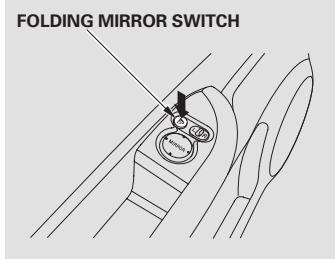

Door mirrors can be folded by the folding switch next to the selector switch, which enables you to park your vehicle in a limited parking space easily. Make sure you fold out the mirrors before you start driving. With the ignition switch in the ON (II) position, press the folding switch to fold up both outside mirrors simultaneously. To fold out, press the switch again.

Never drive your vehicle with the outside mirrors folded.





Parking Brake

Parking Brake Handle (On Manual Transmission Models)

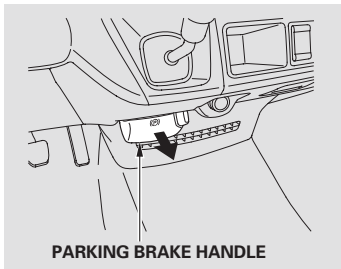

To apply the parking brake, firmly pull the parking brake handle toward you without pushing the release button.

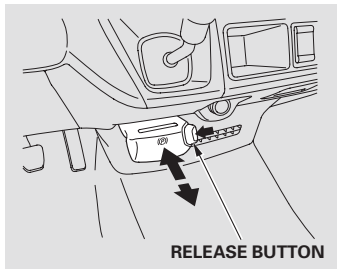

To release the parking brake, pull the handle toward you slightly and push and hold the release button, then return the handle.

You will not be able to relock the parking brake without returning the lever all the way back.

The parking brake indicator on the instrument panel should go out when the parking brake is fully released (see page 75).

While the parking brake is applied, the handle will spring back without pushing the release button if the handle is pushed in.

NOTICE

Driving the vehicle with the parking brake applied can damage the rear brakes and axles. A beeper will sound if the vehicle is driven with the parking brake on.





Parking Brake

Parking Brake Pedal (On Automatic Transmission Models)

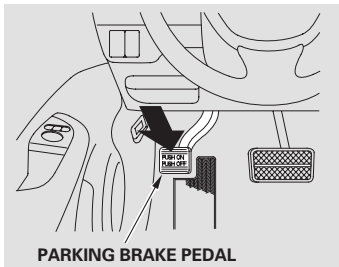

To apply the parking brake, push the pedal down with your foot. To release it, push on the pedal again. The parking brake indicator on the instrument panel should go out when the parking brake is fully released (see page 75).

NOTICE

Driving the vehicle with the parking brake applied can damage the rear brakes and axles. A beeper will sound if the vehicle is driven with the parking brake on.





Interior Convenience Items

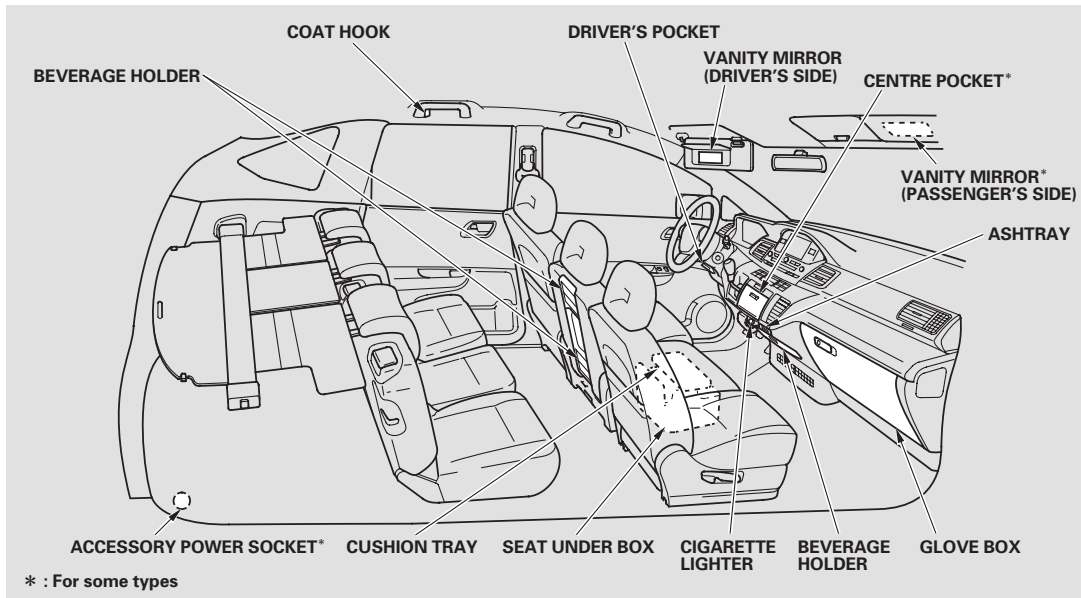

130 Instruments and Controls





Interior Convenience Items

Glove Box

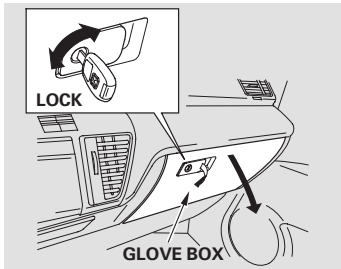

Open the glove box by pulling the handle. Close it with a firm push.

You can lock or unlock the glove box with the ignition key.

The glove box light comes on when the light control switch is in the ☺ or ☹ position.

⚠ WARNING

An open glove box can cause serious injury to your passenger in a crash, even if the passenger is wearing the seat belt.

Always keep the glove box closed while driving.

Cushion Tray

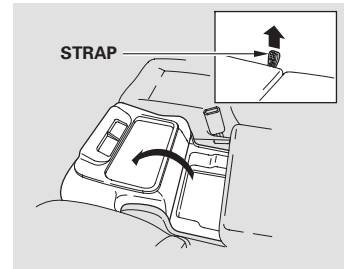

To use the cushion tray, pull the strap, and pivot the seat cushion forward.





Interior Convenience Items

Beverage Holders

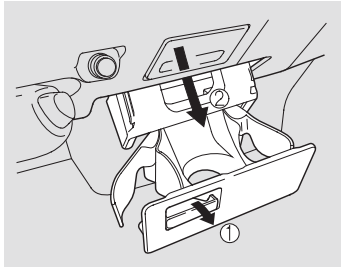

To open the beverage holder, pull out the holder by pulling the handle. Close it with a firm push.

Be careful when you are using the beverage holders. A spilled liquid that is very hot can scald you or your passengers. Spilled liquids can damage the upholstery, carpeting, and electrical components in the interior.

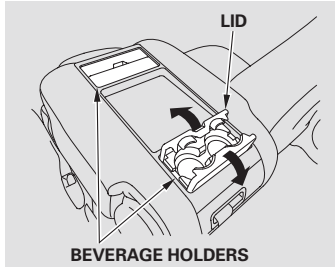

BEVERAGE HOLDERS

The front centre seat also has two beverage holders in its seat-back. Before using it, make sure you fold down the seat-back by pulling the strap (see page 113). To open it, pivot the lid up.

Fold the beverage holders away when returning the seat to the upright position to avoid damaging them.

Driver's Pocket

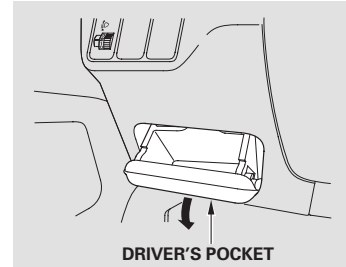

DRIVER'S POCKET

To open the driver's pocket, swing the lid down. Close it with a firm push.

132 Instruments and Controls





Interior Convenience Items

Centre Pocket (For some types)

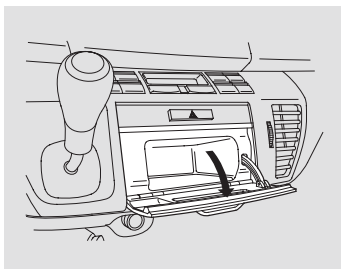

To open the centre pocket, swing the lid down. Close it with a firm push.

Seat Under Box

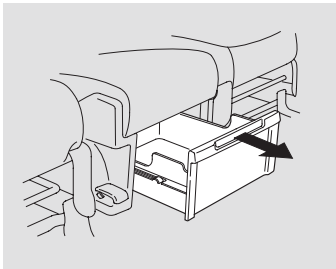

A seat under box is located under the front centre seat. To use it, pull upward slightly on the front centre edge of the box, and slide it out.

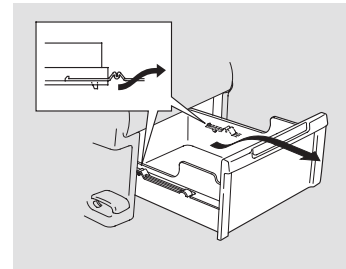

To remove the box for cleaning, pull upward on the front centre edge to disengage the locking tabs under the seat bottom, then pull the box out. Do not try to force the box. You could damage it.





Interior Convenience Items

Coat Hooks

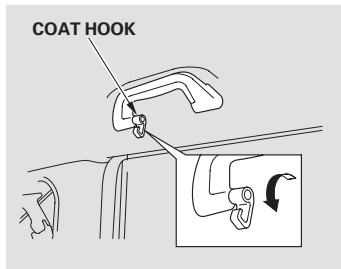

To use a coat hook, slide it out slightly, then pull it down.

Make sure the coat hooks are pulled up when you are not using them. These hooks are not designed for large or heavy items.

Vanity Mirror

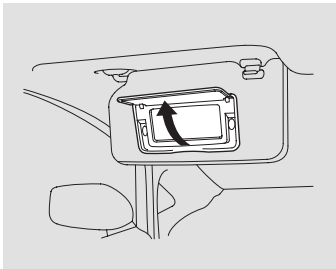

Pull up the vanity mirror cover to use it.

On some models
There is also a vanity mirror on the passenger's side.

Cigarette Lighter

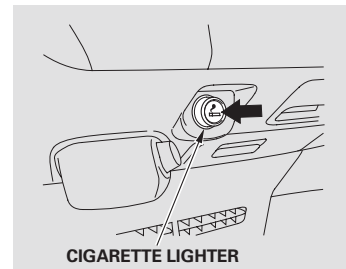

The ignition switch must be in the ACCESSORY (I) or the ON (II) position for the cigarette lighter to work. To heat up the lighter, push it in. It will pop out when it is ready for use. Do not hold the lighter in while it is heating up, you could cause it to overheat.

134 Instruments and Controls





Interior Convenience Items

Ashtray

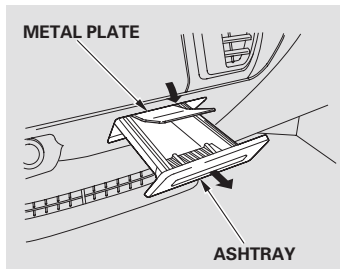

Open the ashtray by pulling on the bottom edge. Push it in to close it. To remove the ashtray for emptying, push down on the metal plate inside, then pull the ashtray out completely.

NOTICE

Use the ashtray only for cigarettes, cigars, and other smoking materials. To prevent a possible fire and damage to your vehicle, don't put paper or other things that can burn in the ashtray.

Accessory Power Socket (For some types)

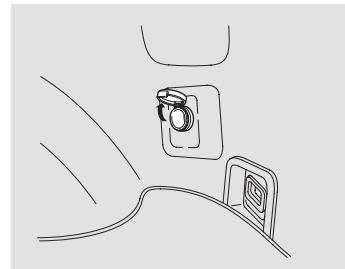

To use the accessory power socket, pull up the cover. The ignition switch must be in the ACCESSORY (I) or ON (II) position.

This socket is intended to supply power for 12 volt DC accessories that are rated 120 watts or less (10 amps). It will not power an automotive type cigarette lighter element.





Interior Lights

Ceiling Lights

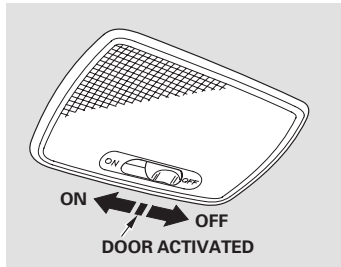

Your vehicle has the front and rear ceiling lights as standard equipment.

Each ceiling light has a three-position switch; ON, door activated (centre), and OFF.

In the ON position, the ceiling light stays on continuously. In the OFF position, the light does not come on.

In the door activated position, both front and rear ceiling lights come on when you:

- Open any door and tailgate.
- Remove the key from the ignition switch. If you do not open a door, the light fades out in about 30 seconds.
- Unlock the doors with the key or remote transmitter.

The light fades out and it goes off 30 seconds after you close all the doors or tailgate.

The light goes off soon after you lock the driver's door or you turn the ignition switch to the ON (II) position.

If you leave any door open when the key is not in the ignition switch, the ceiling light will go off after 3 minutes.





Interior Lights

Spotlights

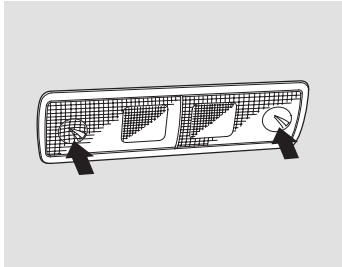

Turn on each spotlight by pushing the lens. Push the lens again to turn it off. You can use the spotlights at all times.

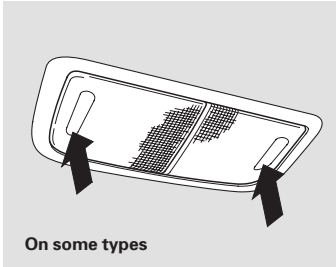

On some types

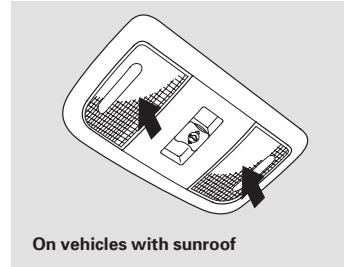

On vehicles with sunroof





Interior Lights

Ignition Switch Light

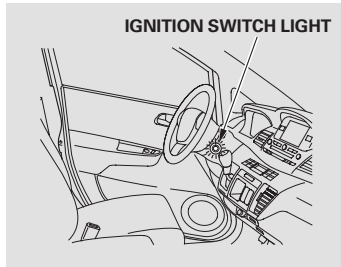

If you leave the driver's door open with the key is not in the ignition switch, the ignition switch light will go off after 3 minutes.



The ignition switch light comes on when you unlock the driver's door. It fades out in about 30 seconds after you close the driver's door, goes off soon after you turn the ignition switch to the ON (II) position, goes off 30 seconds after you remove the ignition key, and it goes off soon after you lock the driver's door.

138 Instruments and Controls





Features

The climate control system in your vehicle provides a comfortable driving environment in all weather conditions.

The audio system that is standard equipment on some models has many features. This section describes those features and how to use them. (If you selected an optional audio system, refer to the operating instructions that came with it.)

On some types
The security system helps to discourage vandalism and theft of your vehicle.

Climate Control System	140
Automatic Climate Control.....	146
Semi-automatic Operation	147
Sunlight and Temperature Sensor	147
Audio System	148
Playing the Radio.....	148
Playing a CD.....	161
CD Changer	166
Protecting Your CDs.....	171
CD Player Error Messages	172
CD Changer Error Messages	173
Setting the Clock	174
Remote Audio Controls.....	176
Auxiliary Input Jack.....	176
Security System	177
Cruise Control.....	179





Climate Control System

Proper use of the climate control system can make the interior dry and comfortable, and keep the windows clear for best visibility.

For the climate control system to provide heating and cooling, the engine must be running.



Vent Controls

CENTRE UPPER VENT (Driver's side)

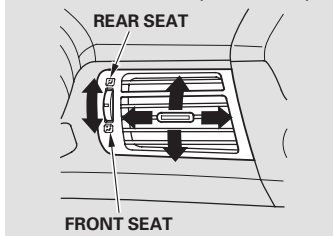

The direction of airflow from the vents in the centre and each side of the dashboard is adjustable.

To adjust the air flow from each vent, move the tab up-and-down and side-to-side.

The centre upper vent can be switched to use for the front seat or to use for the rear seat by turning the dial.

CENTRE LOWER VENT

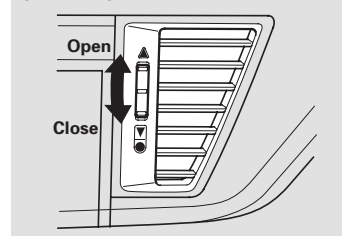

The centre lower and corner vents can be opened or closed by turning the dial.





06/10/30 17:00:43 32SJD620_144



Climate Control System

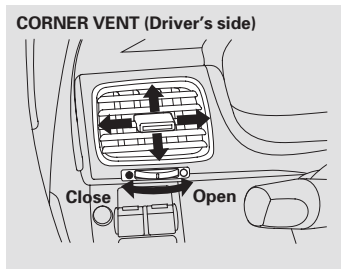

To adjust the airflow from each vent, move the tab up-and-down and side-to-side.

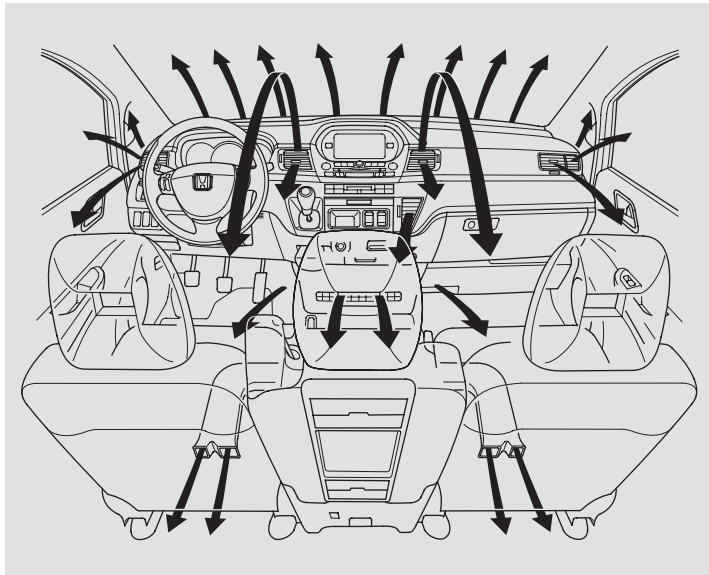

Features **141**





Climate Control System

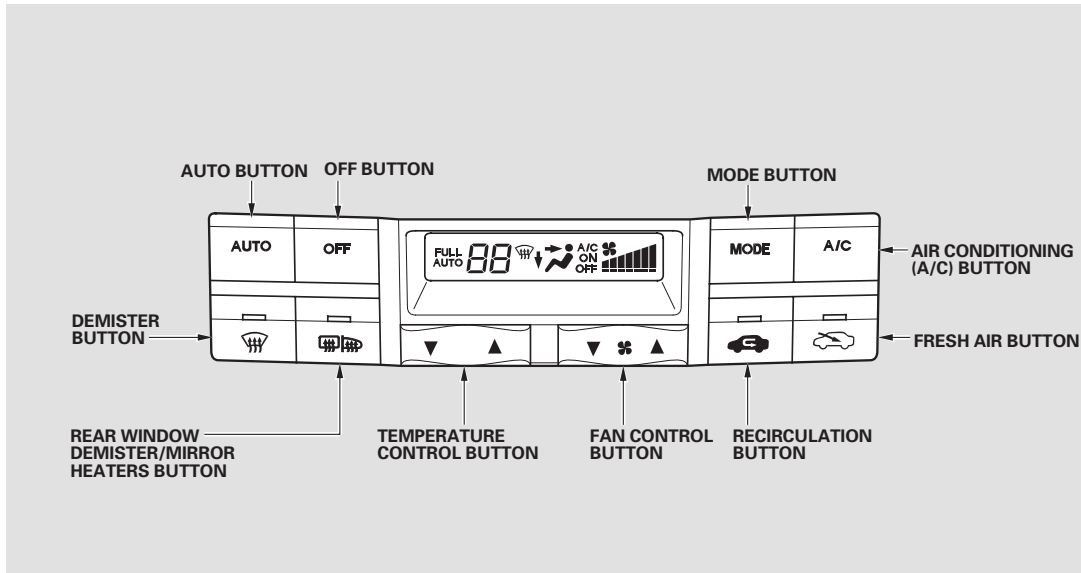

142 Features





06/10/30 17:01:00 32SJD620_146



Climate Control System

Fan Control Button

Push the ▲ button to increase the fan speed and air flow. Push the ▼ button to decrease it.

Temperature Control Button

Push the ▲ button to increase the temperature of air flow. Push the ▼ button to decrease it. When you set the temperature to its lower limit or its upper limit, it will be displayed as “Lo” or “Hi”.

Air Conditioning (A/C) Button



This button turns the air conditioning on and off. You will see A/C ON or A/C OFF in the display.

When you turn the A/C off, the system cannot regulate the inside temperature if you set the temperature control below the outside temperature.

Rear Window Demister Button

This button turns the rear window demister off and on (see page 94).

Fresh Air and Recirculation Buttons

These two buttons control the source of air going into the system. In fresh air mode , air comes from outside the vehicle. In recirculation mode , the interior air recycles through the system.

The outside air intakes for the heating and cooling system are at the base of the windscreen. Keep this area clear of leaves and other debris.

The system should be left in fresh air mode under almost all conditions. Keeping the system in recirculation mode, particularly with the A/C off, can cause the windows to fog up.

Switch to recirculation mode when driving through dusty or smoky conditions, then return to fresh air mode.







Climate Control System

Mode Control Button

Use the mode control dial to select the vents the air flows from. Some air will flow from the dashboard corner vents in all modes.

 Air flows from the centre and corner vents in the dashboard.

 Airflow is divided between the vents in the dashboard and the floor vents.

 Air flows from the floor vents.

 Airflow is divided between the floor vents and demister vents at the base of the windscreen.

 Air flows from the demister vents at the base of the windscreen.

When you select  , the system automatically switches to fresh air mode and turns on the A/C. (The A/C indicator will not come on in the display).

Ventilation

The flow-through ventilation system draws in outside air, circulates it through the interior, then discharges it through vents near the tailgate.

1. Set the temperature to maximum.
2. Make sure the A/C is off.
3. Select  and Fresh Air mode.
4. Set the fan to the desired speed.





Climate Control System

Using the Heater

The heater uses engine coolant to warm the air. If the engine is cold, it will be several minutes before you feel warm air coming from the system.

1. Select  and Fresh Air mode.
2. Set the fan to the desired speed.
3. Adjust the warmth of the air with the temperature control buttons.



Using the A/C

Air conditioning places an extra load on the engine. Watch the engine coolant temperature gauge (see page 82). If it moves near the red zone, turn off the A/C until the gauge reading returns to normal.

1. Turn on the A/C by pressing the button. A/C ON will be displayed on the panel.
2. Make sure the temperature is set to maximum heat.
3. Select .
4. If the outside air is humid, select the Recirculation mode. If the outside air is dry, select the Fresh Air mode.
5. Set the fan to the desired speed.

If the interior is very warm, you can cool it down more rapidly by partially opening the windows, turning on the A/C, and setting the fan to maximum speed in fresh air mode.

Dehumidify the Interior

Air conditioning, as it cools, removes moisture from the air. When used in combination with the heater, it makes the interior warm and dry.

1. Turn the fan on.
2. Turn on the air conditioning.
3. Select  and fresh air mode.
4. Adjust the temperature to your preference.

This setting is suitable for all driving conditions whenever the outside temperature is above 0°C (32°F).







Climate Control System



To Defog and Defrost

To remove fog from the inside of the windows:

1. Set the fan to the desired speed, or high for faster defrosting.
2. Select . The system automatically switches to Fresh Air mode and turns on the A/C. (The A/C indicator will not come on in the display)
3. Adjust the temperature so the airflow feels warm.
4. Select  to help clear the rear window.
5. To increase airflow to the windshield, close the corner vents.

When you switch to another mode from , the A/C stays on. (The A/C indicator will not come on in the display). Press the A/C button to turn it off.

To Remove Exterior Frost or Ice From the Windows

1. Select . The system automatically switches to Fresh Air mode and turns on the A/C. (The A/C indicator will not come on in the display).
2. Select .
3. Set the fan and temperature controls to the maximum level.

To clear the windows faster, you can close the dashboard corner vents by rotating the wheel below it. This will send more warm air to the windshield defroster vents. Once the windshield is clear, select the fresh air mode to avoid fogging the windows.

For your safety, make sure you have a clear view through all the windows before driving.

Automatic Climate Control

The automatic climate control system adjusts the fan speed and airflow levels to maintain the interior temperature you select, and it controls switching fresh air/interior air recirculation as well.

1. Press the AUTO button.
2. Set the desired temperature with the temperature control buttons. You will see FULL AUTO in the system's display.

The system automatically selects the proper mix of conditioned and/or heated air to raise or lower the interior temperature to the temperature you selected.

If you set the temperature to its lower limit or its highest limit, the system runs at full cooling or heating only. It does not regulate the interior temperature.





Climate Control System

In cold weather, the fan will not come on automatically until the heater starts to develop warm air.

Semi-automatic Operation

You can manually select various functions of the climate control system when it is in fully automatic mode. All other features remain automatically controlled. Making any manual selection causes the word FULL in the display to go out.

To Turn Everything Off

Press the OFF button. However, a lack of airflow can cause the windows to fog up. You should keep the fan on at all times so stale air and moisture do not build up in the interior and cause fogging.

Sunlight and Temperature Sensors

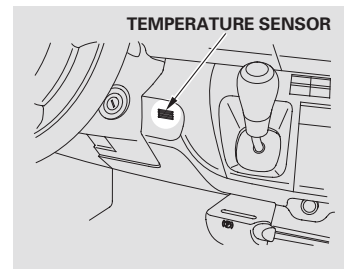
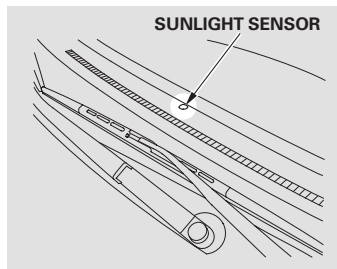

The climate control system has two sensors. A sunlight sensor is in the top of the dashboard, and a temperature sensor is next to the steering column. Do not cover the sensors or spill any liquid on them.





Audio System

Your vehicle has one of the audio systems described in this section. Read the following pages for operation of the audio systems installed in your vehicle.

If your vehicle has a different audio system from these types, read the radio manufacturer's manual that came with your vehicle for its operation.



Playing the Radio

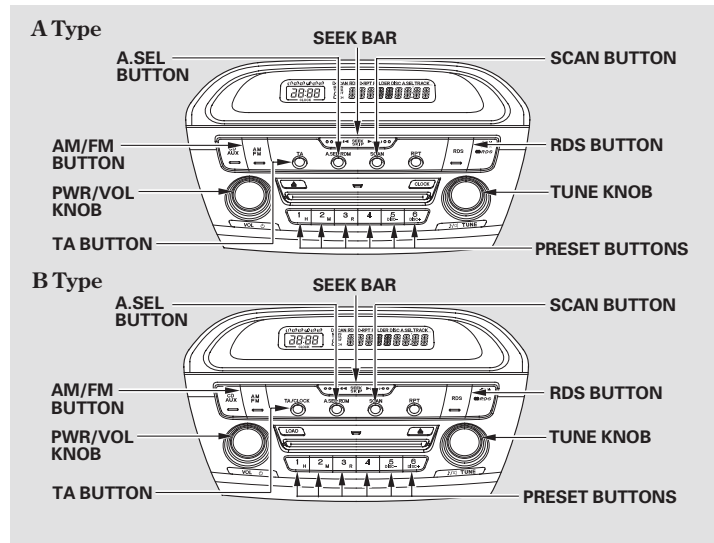



Audio System

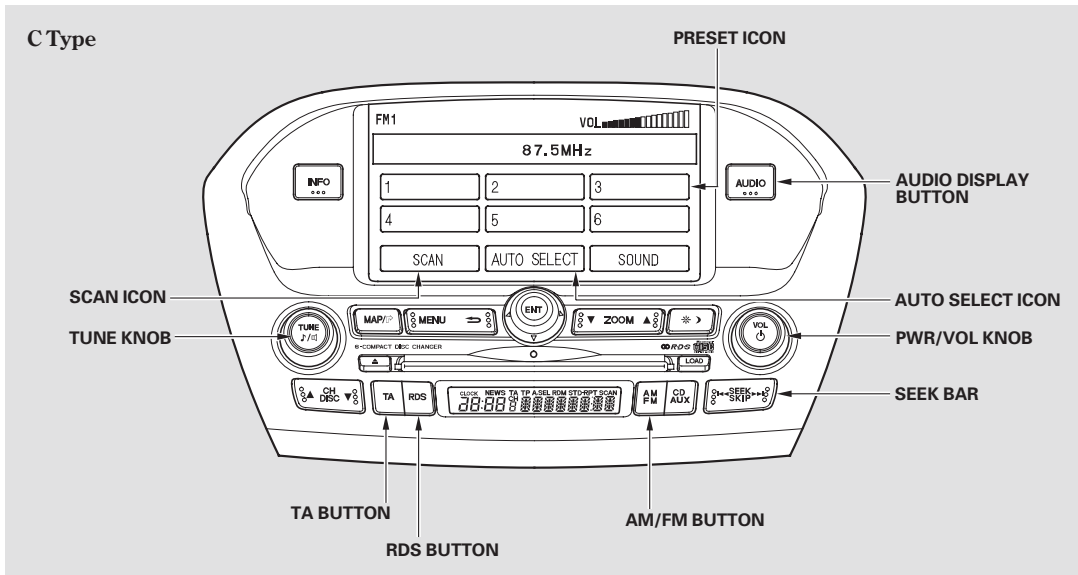



Audio System

To Play the Radio

The ignition switch must be in the ACCESSORY (I) or ON (II) position. Turn the system on by pushing the PWR/VOL knob or the AM/FM button. Adjust the volume by turning the same knob.

The band and frequency that the radio was last tuned to is displayed. To change bands, press the FM/AM button. On the FM band, ST will be displayed if the station is broadcasting in stereo. Stereo reproduction on AM is not available.

To Select a Station

You can use these five methods to find radio stations on a selected band: **TUNE**, **SEEK**, **SCAN**, the preset buttons or preset icons (models with navigation system), and **AUTO SELECT**.

TUNE — Use the TUNE knob to tune the radio to a desired frequency. Turn the knob right to tune to a higher frequency, or left to tune to a lower frequency.

SEEK — The seek function searches up and down from the current frequency to find a station with a strong signal. To activate it, press the ◀◀ or ▶▶ side of the bar, then release it.





Audio System

SCAN – The SCAN function samples all stations with strong signals on the selected band. To activate it, press the SCAN button or touch the SCAN icon (models with navigation system), then release it. You will see SCAN in the display. The system will scan for a station with a strong signal. When it finds one, it will stop and play that station for about 10 seconds.

If you do nothing, the system will then scan for the next strong station and play it for 10 seconds. When it plays a station you want to listen to, press the SCAN button (icon) again.

Preset – Each of the six preset buttons or preset icons (on models with navigation system) can store one frequency on AM (LW, MW) and two frequencies on FM.

1. *On vehicles with navigation system*
Push the AUDIO DISPLAY button to view the audio display. You will see the six preset icons.
2. Select the desired band, AM or FM. FM1 and FM2 let you store two sets of FM frequencies with the preset buttons (on-screen icons).
3. Use the tune, seek, or scan function to tune the radio to a desired station.
4. Pick a preset button (icon), and hold it until you hear a beep.

5. Repeat steps 2 to 4 to store a total of each six stations on AM (LW, MW) and twelve stations on FM.

The preset frequencies may be lost if your vehicle's battery goes dead, is disconnected, or the radio fuse is removed.

CONTINUED

Features **151**





Audio System

AUTO SELECT – If you are travelling far from home and can no longer receive your preset stations, you can use the auto select feature to find stations in the local area.

Press the A.SEL button or the AUTO SELECT icon (models with navigation system). “A.SEL” flashes in the display, and the system goes into scan mode for several seconds. It stores the frequencies of six FM stations in the preset buttons (icons).

You will see a “0” displayed after pressing a preset button (icon) if Auto Select cannot find a strong station for every preset button.

If you do not like the stations Auto Select has stored, you can store other frequencies on the preset buttons (icons). Use the TUNE, SEEK, or SCAN function to find stations, then store them in the preset buttons (icons) as described previously.

To turn off Auto Select, press the A.SEL button (AUTO SELECT icon). This restores the presets you originally set.





Audio System

Radio Data System (RDS)

Features

With your audio system, you can utilize many convenient features provided by the radio data system (RDS).

With the FM band selected, you can keep listening to the same station even if its frequency changes as you enter different regions while you are travelling.

The RDS function turns on automatically when you turn the system on. If the station you are listening to is an RDS station, the frequency display will disappear and the station name will be displayed. Then, the system will automatically keep selecting the frequency with the strongest signal from the frequencies that carry the same programs. This can save you the trouble of re-tuning to obtain the same station as long as you are in the same RDS network area.

You can turn on or off the RDS functions. To switch each function on or off, press the PWR/VOL knob for more than 2 seconds with the audio system on. It shows AF, REG, PS, A-PI, A-TP, CT (except C type) and CLK on the display each time you push the TUNE knob. Then, turn the TUNE knob left (off) or right (on). To set the RDS functions on or off, press the PWR/VOL knob again.

CONTINUED

Features 153





Audio System

AF (Alternative Frequency) – AF automatically selects a similar program as the one in play from another station in the adjacent area.

REG (Regional Program) – With this function selected, the radio “knows” that certain broadcasters do not air the same programs at the same time. In REG mode, the radio remains tuned into the regional program and will not change to another frequency to compensate for weak reception.

PS (Program Service) – PS shows the name of the radio station to which you tuned into.

A-PI (Program Identification Code) – When a similar program is broadcasted from some radio stations in different countries or areas, it automatically selects only the given program. When the radio wave the system is receiving becomes weak, it automatically selects the similar program broadcasted with the stronger radio wave from another station.

A-TP (Traffic Programs) – It automatically tunes in to the radio station that is broadcasting traffic information.

CT (Clock Time) – It automatically puts the clock right based on the data broadcasted from the radio station.

CLK (Clock) – It switches the clock display to either the 12-hour system or the 24-hour system.

When the signals of the RDS station become so weak that the system can no longer follow the station, the system will hold the last tuned frequency and the display will change from the station name to the frequency.

In some countries, you cannot utilize features provided by RDS as the RDS function is not provided for all stations.





Audio System

Program Service Name Display

If the station you are listening to is an RDS station, the frequency display will disappear and the station name or PTY information will be displayed. Press the RDS button for less than 2 seconds to switch the display information between the name of network/station and the PTY information (see page 156 for the PTY display information).

TA (Traffic Announcement Standby) Function

When the TA button is pressed, "TA" will light on the display and the system will stand by for traffic announcements.

When a traffic information (TP) station is selected, "TP" will light on the display indicating that traffic reports can be received from this station. When the EON (Enhanced Other Network) TP station is selected, "TP" will also light on the display.

EON information cross-references other program services that broadcast traffic information, and when EON information is received, traffic reports can be received through another program service.

You can receive traffic information while you are listening to a CD. If the system is tuned to a TP or EON TP station before playing a CD, the system will stand by for traffic announcements by pressing the TA button ("TA" indicator ON) and the system will switch from CD to the traffic announcement when it begins. The system will return to the CD

mode when the traffic information is finished.

To adjust the volume of the traffic announcement, turn the PWR/VOL knob whilst the announcement is being broadcast. The volume level selected will be retained the next time a traffic announcement is made. This will also adjust the volume of PTY NEWS and PTY ALARM interruption functions (see page 158).

To turn off the TA function, press the TA button again. "TA" will go out from the display.

If you use SEEK or Auto Select with the TA function ON, the system searches only TP or EON TP stations.

CONTINUED

Features 155





Audio System

PTY Display Function

When the RDS button is pressed for less than two seconds, the PTY display function turns on. This function lets you know the type of programs the selected RDS station is broadcasting. For example, if the station is broadcasting dramas, "DRAMA" is shown in the display. If it is a station of scientific programs, "SCIENCE" will be shown. The principal PTYs are shown as follows.

AFFAIRS : Topical programs expanding upon the news.
CLASSICS : Serious classics; performances of major orchestral works.
CULTURE : Programs concerned with any aspect of national or regional culture.
DRAMA : All radio plays and serials.
EASY MUS : M.O.R MUSIC.
EDUCATE : Educational programs.
INFO : General information and advice.
L.CLASS : Light classics; classical music for non-specialist appreciation.
NEWS : Short accounts of facts, events, publicly expressed views, reportage, etc.
OTH MUS : Other types of music, such as Jazz, R & B, Folk, Country, Reggae.
POP MUS : Commercial music of popular appeal.
ROCK MUS : Contemporary modern music.

SCIENCE : Programs about nature, science, and technology.
SPORT : Programs concerned with any aspect of sports.
VARIED : Light entertainment programs.





Audio System

After you select the desired program type, the system will search for a station with the same PTY code as the selected program type. When you use this function for the first time, "NEWS" will appear as it was preset at the factory.

If the selected RDS station does not transmit PTY data, "NO PTY" is displayed. When the selected station is not an RDS station, "NO RDS" is displayed for about 5 seconds. The PTY display function turns off and the display returns to normal if no further steps are taken.

While a PTY is displayed, you can use the SEEK bar to find a station of the desired PTY. When you use the TUNE knob, the display will show different PTYs (see the PTYs list on the previous page).

The PTY setting mode is cancelled if no further steps are taken within 5 seconds after selecting the desired PTY by operating the SEEK bar.

After your desired PTY is displayed, press either side of the SEEK bar again within 5 seconds. The system will go into the PTY search mode and it will search for a station of the selected PTY. If there is no station available in the selected PTY, "NO PTY" is displayed for about 5 seconds and the PTY search mode is cancelled.

Some stations may broadcast the programs which have different contents from their PTY code.

In the PTY search mode, the tuning step is set to 50 kHz while searching on the FM band. This step changes to 100 kHz when the AF or TA function is activated.

CONTINUED

Features 157





Audio System

PTY/News Interrupt Function

To activate this function, press the RDS button for more than 2 seconds and select “**NEWS**”. The system will hold the last tuned FM station/network PTY while you are listening to the CD. With this function on, the playing CD is interrupted and the system switches from CD mode to the FM newscast when the newscast is broadcasting from the FM station.

When the program is changed to another program or the frequency cannot be received for 10 seconds due to weak signal, the system will return to the CD mode automatically.

Your audio system has another interrupt function (including TA function). The interrupt function first activated has priority over the others and the indication of the other interrupt function goes out. To activate the other interrupt function, turn off the currently activated interrupt function.

PTY Alarm

PTY code “**ALARM**” is used for emergency announcements, such as natural disasters. When this code is received, “**ALARM**” goes on the display and the volume is changed. When the alarm is cancelled, the system will return to the normal operation mode.





Audio System

Adjusting the Sound

Press the TUNE knob repeatedly to display the Bass (BASS), Treble (TREB), Fader (FAD), Balance (BAL), and speed-sensitive volume compensation (SVC) settings.

Each mode is shown in the display as it changes. Turn the TUNE knob to adjust the setting to your liking.

Balance/Fader – These two modes adjust the strength of the sound coming from each speaker. BAL adjusts the side-to-side strength, while FAD adjusts the front-to-back strength.

Treble/Bass – Use the TREB/BASS modes to adjust the tone to your liking.

When the level reaches the centre, you will see “C” in the display. You will also hear a beep whenever the adjustment level reaches the centre

(), maximum, and minimum of its range.

Speed-sensitive Volume Compensation (SVC) – The SVC mode controls the volume based on vehicle speed. The faster you go, the louder the audio volume becomes. As you slow down, the audio volume decreases.

The SVC has four modes; SVC OFF, SVC LOW, SVC MID, and SVC HIGH. The default setting is MID. Turn the SOUND (TUNE) knob to adjust the setting to your liking. If you feel the sound is too loud, choose low. If you feel the sound is too quiet, choose high.

The system will automatically return the display to the selected audio mode about 5 seconds after you stop adjusting a mode.







Audio System

On models with Navigation System

Adjusting the Sound
Bass, Treble, Balance, and Fader are each adjustable. To adjust them, enter the sound grid by touching the SOUND icon on the display or pressing the TUNE knob.

Treble/Bass – To adjust the bass and treble, touch the  or  icon on each side of the Treble or Bass adjustment bar. The adjustment bar next to the Treble or Bass icon shows you the current setting.

Balance/Fader – These two modes adjust the strength of the sound coming from each speaker. Left and Right icons adjust the side-to-side strength, while Front and Rear icons adjust the front-to-back strength.

To adjust the balance, touch the left or right icon on the sound grid. When you touch an icon, the yellow bars on the grid move toward it, changing the balance left or right. To equalize the balance, touch the left or right icon until each side has a yellow bar at the centre of the sound grid.

To adjust the fader, touch the front or rear icon on the sound grid. When you touch an icon, the white bars on the grid move toward it, changing the fader to the front or rear. To equalize the fader, touch the front or rear icon until each side has a white bar at the centre of the sound grid.

To see the audio screen when you are finished adjusting the sound, wait 5 seconds.

If you want to adjust the sound while the radio/CD is playing, push the AUDIO DISPLAY button or TUNE knob, then touch the SOUND icon in the display.

To return to the previous display, wait about for 5 seconds after you stop adjusting the sound.





Audio System

Playing a CD

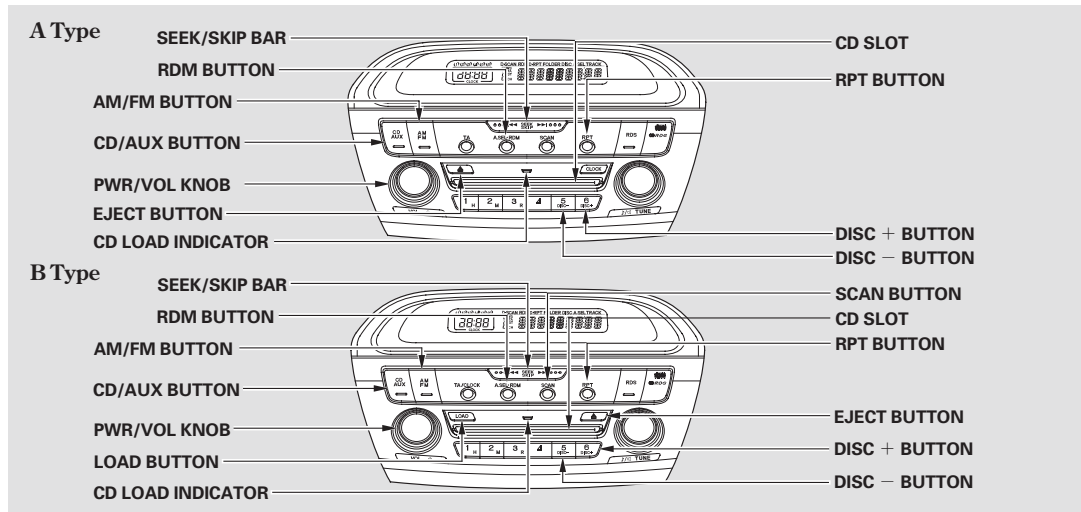

CONTINUED





Audio System

On A type

With the ignition in the ACCESSORY (I) or ON (II) position, insert a CD into the CD slot. The drive will pull the CD in the rest of the way and begin to play it.

You operate the CD player with the same controls used for the radio. The number of the track playing is shown in the display. The system will continuously play a CD until you change modes.

NOTICE

Do not use discs with adhesive labels. The label can curl up and cause the disc to jam in the unit.

To Change Tracks (SKIP)

Each time you press and release **▶▶**, the player skips forward to the beginning of the next track. Press and release **◀◀** to skip backward to the beginning of the current track. Press it twice to skip to the beginning of the previous track.

To move rapidly within a track, press and hold **▶▶** or **◀◀**.

REPEAT — To continuously replay a track, press and release the RPT button. You will see RPT in the display. Press it again to turn it off.

RANDOM — Press and release the A.SEL/RDM button to play the tracks in random order. You will see RDM in the display. Press the A.SEL/RDM button again to return to normal play.





Audio System

To Stop Playing a CD

Press the eject button () to remove the CD.

If you eject the CD, but do not remove it from the slot, the system will automatically reload the CD after 10 seconds and put it in pause mode. To begin playing, press the CD button.

Press the AM/FM button to switch to the radio while a CD is playing. Press the CD button to play the CD.

If you turn the system off while a CD is playing, either with the PWR/VOL knob or by turning off the ignition, the CD will stay in the drive. When you turn the system back on, the CD will begin playing where it left off.

Operating the Optional CD Changer

An optional six disc CD changer is available for your vehicle from your dealer. This disc changer uses the same controls used for the in-dash CD player or the radio.

Load the desired CDs into the magazine, and load the magazine into the changer according to the instructions that came with the unit.





Audio System

To select the CD changer, press the CD button. The disc and track numbers will be displayed. To select a different CD, use the Preset 5 (DISC -) or Preset 6 (DISC +) button. To select the previous disc, press the Preset 5 (DISC -) button or Preset 6 (DISC +) button to select the next disc in sequence.

If you select an empty slot in the magazine, the changer will, after finding that slot empty, try to load the CD in the next slot.

To use the SKIP, REPEAT, and RANDOM functions, refer to the in-dash player operating instructions.





Audio System

Operating the In-Dash CD Changer

Except A type

Your Honda's audio system has an in-dash CD changer that holds up to six discs, providing several hours of continuous entertainment. You operate this CD changer with the same controls used for the radio.

To load CDs or operate the CD changer, the ignition switch must be in the ACCESSORY (I) or ON (II) position.

Load and play only standard round discs. Odd-shaped CDs may jam in the drive or cause other problems. You cannot load and play 8-cm (3-inch) discs in this system.

NOTICE

Do not use discs with adhesive labels. The label can curl up and cause the disc to jam in the unit.

166 Features

Loading CDs in the Changer

To load multiple CDs in one operation:

1. Press and hold the LOAD button until you hear a beep, then you see "LOAD" in the display.
2. Insert the disc into the CD slot. Insert it only about halfway; the drive will pull it in the rest of the way. You will see "BUSY" in the display. The CD load indicator turns red and blinks as the CD is loaded.
3. When "LOAD" appears again in the display, insert the next disc into the CD slot.

4. Repeat this until all six positions are loaded. The system will then begin playing the last CD loaded.

If you stop loading CDs before all six positions are filled, the system will wait for 10 seconds, then stop the load operation and begin playing the last CD loaded.





Audio System

To load a single CD:

1. Press and release the LOAD button.
2. You will see "BUSY" in the display. The CD load indicator turns red and blinks. Then, the green CD load indicator comes on. When you see "LOAD" in the display, insert the disc into the CD slot. Insert it only about halfway; the drive will pull it in the rest of the way.

If you press the LOAD button while a CD is playing, the system will stop playing that CD and start the loading sequence. It will then play the CD just loaded.

To Play a CD

Select the CD changer by pressing the CD/AUX button. The system will begin playing the last selected disc in the CD changer. You will see the disc and track numbers displayed.

To select a different CD when all six positions are loaded, use the preset 5 (DISC -) or preset 6 (DISC +) button. Otherwise, press the corresponding number on the preset buttons. On models with navigation system, you can also touch the appropriate disc icon (1-6) or CH DISC button to select a different CD.

You can use the SKIP bar while a disc is playing to select passages and change tracks.

To move rapidly within a track, press and hold the left or right of the SKIP bar. You will hear a beep and the system will continue to move through the track. Press ►► to move forward, or ◄◄ to move backward. Release the bar when the system reaches the point you want.

Each time you press and release the ►► side of the SKIP bar, the system skips forward to the beginning of the next track. Press and release the ◄◄ side to skip backward to the beginning of the current track.





Audio System

Track Scan

When you press the SCAN button or touch the TRACK SCAN icon on the audio display (models with navigation system), the first track of the current CD plays for about 10 seconds. You will see SCAN (TRACK SCAN) highlighted in the display. To hear the rest of the track, press the SCAN button or touch TRACK SCAN again within 10 seconds. If you don't, the system advances to the next track, plays about 10 seconds of it, and continues through the rest of the tracks the same way.

Disc Scan

When you press and hold the SCAN button until you see D-Scan in the display, or when you touch the DISC SCAN icon on the audio display (models with navigation system), the first track of the current CD plays for about 10 seconds. You will see D-Scan (DISC SCAN) in the display. To hear the rest of the CD, press the SCAN button or touch DISC SCAN again, within 10 seconds. If you don't, the system advances to the next CD, plays about 10 seconds of it, and continues throughout the rest of the CDs the same way. When the system reaches the last disc, DISC SCAN is cancelled, and the CD plays normally.

Track Repeat

When you press the RPT button or touch the TRACK RPT icon on the audio display (models with navigation system), the system continuously replays the current track. As a reminder, you will see RPT (TRACK REPEAT) in the display. To turn this feature off, touch TRACK REPEAT again.

Disc Repeat

When you press and hold the RPT button until D-RPT is in the display, or when you touch the DISC RPT icon on the audio display (models with navigation system), the system continuously replays the current CD. As a reminder, D-RPT (DISC RPT) is highlighted in the display. To turn this feature off, press the SCAN button or touch DISC RPT again.





Audio System

Random Play

When you press the RDM button or touch the RANDOM icon (models with navigation system), the system plays the tracks of the current CD in random order. You will see RDM (TRACK RANDOM) in the display. To turn this feature off, press the RDM button (touch the RANDOM icon) again.

Removing CDs from the Changer

To remove the CD that is currently playing, press the eject button. You will see "EJEC" ("EJECT") in the display. When you remove the CD from the slot, the system automatically begins the load sequence so you can load another CD in that position. If you do not load another CD, the system selects the previous mode (AM/LW, AM/MW, FM1, or FM2).

If you do not remove the CD from the slot, the system will reload the CD after 10 seconds and put the CD changer in pause mode. To begin playing the CD, press the CD button.

To remove a different CD from the changer, first select it by pressing the corresponding number on the preset button (touching the appropriate disc icon on models with navigation system). When that CD begins playing, press the eject button.

CONTINUED

Features 169





Audio System

If you press the eject button while listening to the radio, or with the audio system turned off, the disc that was last selected is ejected. After that disc is ejected, pressing the eject button again will eject the next disc in numerical order. By doing this six times, you can remove all the CDs from the changer.

You can also eject discs when the ignition switch is on or off:

To eject one disc, press and release the eject button.

To eject all discs, press and hold the eject button.

Operating the Optional MD Player/Changer (For some types)

An MD player or changer is available for your vehicle as optional equipment. You can operate this MD player/changer with the same controls used for the audio system in the Navigation System. Follow the instructions that came with the unit.





Protecting Your CDs

General Information

- When using CD-R or CD-RW discs, use only high quality CDs labelled for audio use.
- When recording a CD-R or CD-RW, the recording must be closed for it to be used by the CD changer.
- Play only standard round CDs. Odd-shaped CDs may jam in the drive or cause other problems.
- Handle your CDs properly to prevent damage and skipping.

Protecting CDs

When a CD is not being played, store it in its case to protect it from dust and other contamination. To prevent warpage, keep CDs out of direct sunlight and extreme heat.

To clean a CD, use a clean soft cloth. Wipe across the CD from the centre to the outside edge.

A new CD may be rough on the inner and outer edges. The small plastic pieces causing this roughness can flake off and fall on the recording surface of the CD, causing skipping or other problems. Remove these pieces by rubbing the inner and outer edges with the side of a pencil or pen.

Never try to insert foreign objects in the CD player or the magazine.

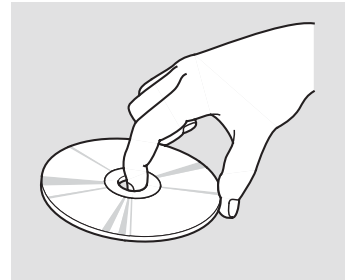

Handle a CD by its edges; never touch either surface. Do not place stabilizer rings or labels on the CD. These, along with contamination from fingerprints, liquids, and felt-tip pens, can cause the CD to not play properly or possibly jam in the drive.





CD Player Error Messages

The chart on the right explains the error messages you may see in the display while playing a disc.

If you see an error message in the display while playing a disc, press the eject button. After ejecting the disc, check it for damage or deformation. If there is no damage, insert the disc again.

If there is still a problem, the error message will appear again. Press the eject button, and pull out the disc.

Insert a different disc. If the new disc plays, there is a problem with the first disc. If the error message cycle repeats and you cannot clear it, take your vehicle to a dealer.

Error Message	Cause	Solution
DISC	FOCUS Error/ System Error	Press the eject button and pull out the CD. Check if it is inserted correctly in the CD player. Make sure the CD is not scratched or damaged.
ERROR	Mechanical Error	Press the eject button and pull out the CD. Check the CD for damage or deformation. If the CD cannot be pulled out or the error message does not disappear after the CD is ejected, see your dealer.
HOT	High temperature	Will disappear when the temperature returns to normal.





CD Changer Error Messages

The chart on the right explains the error messages you may see in the display while playing a disc.

If you see an error message in the display while playing a disc, press the eject button. After ejecting the disc, check it for damage or deformation. If there is no damage, insert the disc again.

If there is still a problem, the error message will appear again. Press the eject button, and pull out the disc.

Insert a different disc. If the new disc plays, there is a problem with the first disc. If the error message cycle repeats and you cannot clear it, take your vehicle to a dealer.

Error Message	Cause	Solution
CD DISC	FOCUS Error	Press the CD eject button and pull out the CDs. Check for an error message, and insert the CDs again. If message does not disappear or the CDs cannot be pulled out, see your dealer.
CD DISC	No CD in the CD magazine	Insert CDs.
① CD ERROR ② CD ERR	Mechanical Error	Press the magazine eject button and pull out the magazine. Check for an error message, and insert the magazine again. If the message does not disappear or the magazine cannot be pulled out, see your dealer.
CD HOT	High temperature	Will disappear when the temperature returns to normal.
① CD EJECT ② CD EJECT	No CD magazine in the CD changer	Insert CD magazine.

- ① B type
- ② C type





Setting the Clock

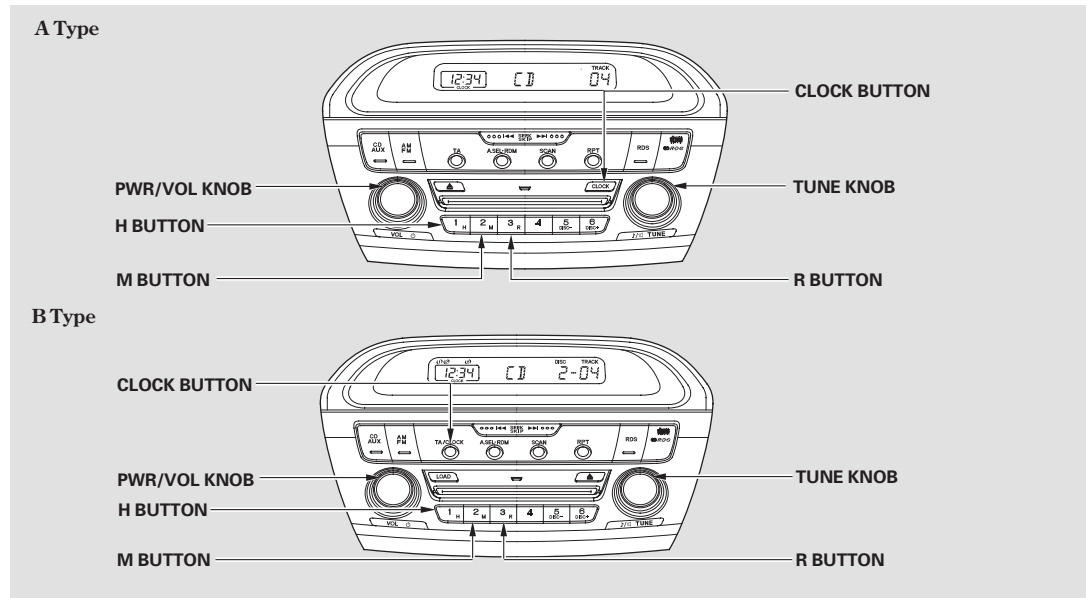



Setting the Clock

If your vehicle's battery is disconnected or goes dead, you may need to set the clock.

On A and B types

Press the CLOCK button. The displayed time begins to blink. Change the hours by pressing the H (Preset 1) button. Change the minutes by pressing the M (Preset 2) button.

Press the CLOCK button again to enter the set time.

You can quickly set the time to the nearest hour.

If the displayed time is before the half hour, press the CLOCK button, then press the R (Preset 3) button to set the clock back to the previous hour. If the displayed time is after the half hour, the clock sets forward to the beginning of the next hour.

For example: 1:06 will reset to 1:00
1:53 will reset to 2:00

All types

You can switch the clock display to either the 12-hour system or 24-hour system. To switch the display, press the PWR/VOL knob for more than 2 seconds with the audio system on, and press the TUNE knob until "CLK" is displayed on the display. Turn the TUNE knob left (12-hour) or right (24-hour), and then push the PWR/VOL knob.

On C type

The display shows the time when the ignition switch is in the ACCESSORY (I) or the ON (II) position. The Navigation System receives signals from the Global Positioning System (GPS), and the displayed time is updated automatically by the GPS. Refer to the Navigation System Owner's Manual to set up the time.





Remote Audio Controls, Auxiliary Input Jack

Remote Audio Controls (For some types)

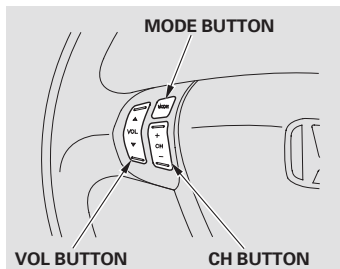

Three controls for the audio system are mounted in the steering wheel hub. These let you control basic functions without removing your hand from the wheel.

The VOL button adjusts the volume up (▲) or down (▼). Press the top or bottom of the button, hold it until the desired volume is reached, then release it.

The MODE button changes the mode. Pressing the button repeatedly selects FM1, FM2, MW, LW or CD (if a CD is loaded).

If you are listening to the radio, use the CH button to change stations. Each time you press the top (+) of the button, the system goes to the next preset station on the band you are listening to. Press the bottom (-) to go back to the previous station.

If you are playing a CD, the system skips to the beginning of the next track each time you press the top (+) of the CH button. Press the bottom (-) to return to the beginning of the current track. Press it again to return to the previous track. You will see the disc and track numbers in the display.

Auxiliary Input Jack (For some types)

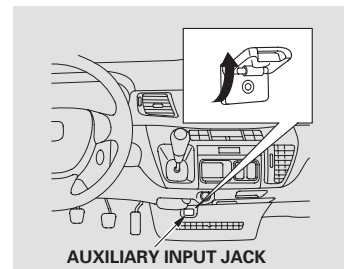

The auxiliary input jack is under the cigarette lighter. The system will accept auxiliary input from standard audio accessories.

When a compatible audio unit is connected to the jack, press the CD/AUX button to select it.

176 Features





Security System (For some types)

The security system helps to protect your vehicle and valuables from theft. The horn sounds (the beeping alarm on vehicles with ultrasonic sensor) and the turn signal lights flash if someone attempts to break into your vehicle or remove the radio. This alarm continues for 30 seconds, then the system resets.

To reset an alarming system before 30 seconds have elapsed, unlock the driver's door with the key or the remote transmitter.

On vehicles with the ultrasonic sensor, only the remote transmitter can reset the security system. Unlocking the driver's door with the key cannot reset the security system.

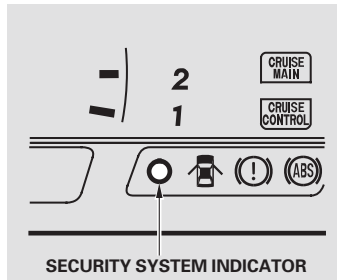

The security system sets automatically 15 seconds (25 seconds with the ultrasonic sensor activated) after you lock the doors, bonnet, and tailgate. For the system to activate, you must lock the doors and the tailgate from the outside with the key, driver's door lock tab, or remote transmitter. The security system indicator on the instrument panel starts blinking immediately to show you the system is setting itself.

On vehicles with ultrasonic sensor
To set the ultrasonic sensor along with the security system, you should lock the doors and the tailgate with the key or the remote transmitter.

When you lock the doors and the tailgate with the key or the remote transmitter, all outside turn signals and both indicators in the instrument panel flash three times to verify the doors and the tailgate are locked and the security system has set. When you unlock them, these lights flash once.

Once the security system is set, opening any door (without using the key or the remote transmitter), the bonnet or the tailgate will cause it to alarm. It also alarms if the radio is removed from the dashboard or the wiring is cut.

CONTINUED

Features 177





Security System (For some types)

The alarm will also be activated if the passenger inside the locked vehicle turns the ignition switch on.

On vehicles with super locking system
When you set the super locking along with the security system, the alarm is not activated if someone tries to open a door with the lock tabs.



The security system will not set if the bonnet, tailgate, or any door is not fully closed. Before you leave the vehicle, make sure the doors, tailgate, and bonnet are securely closed.

Do not attempt to alter this system or add other devices to it.

Ultrasonic Sensor (For some types)

Ultrasonic sensor is only activated when the security system is set by the key or the remote transmitter. A sensor is located near the spotlights on the front ceiling. It monitors the interior of the vehicle and activates the alarm if someone attempts to get into the passenger compartment through a window or sunroof (if equipped), or moves in the compartment. With the security system set, only the ultrasonic sensor may activate.

NOTICE

If you set the security system with the windows or the sunroof open, the ultrasonic sensor may activate the alarm unexpectedly when the system senses strong impacts on the vehicle or loud sound.

You can set the security system without activating the ultrasonic sensor. Remove the ignition key, push the lock tab in with the driver's door open, then close the door. The security system indicator on the instrument panel comes on for 3 seconds, then starts blinking.

Even if the ultrasonic sensor is activated or not, the security system can be reset by only the remote transmitter, not the key.





Cruise Control (For some types)

Cruise control allows you to maintain a set speed above 40 km/h (25 mph) without keeping your foot on the accelerator pedal. It should be used for cruising on straight, open motorways. It is not recommended for city driving, winding roads, slippery roads, heavy rain, or bad weather.

⚠ WARNING

Improper use of the cruise control can lead to a crash.

Use the cruise control only when travelling on open motorways in good weather.

Using the Cruise Control

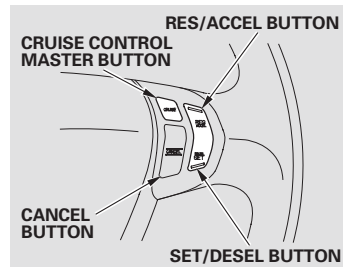

1. Push in the Cruise Control Master Button on the steering wheel. The CRUISE MAIN indicator will come on.
2. Accelerate to the desired cruising speed above 40 km/h (25 mph).

3. Press and release the SET/DECEL button on the steering wheel. The CRUISE CONTROL indicator on the instrument panel comes on to show the system is now activated.

CONTINUED

Features 179





Cruise Control (For some types)

Cruise control may not hold the set speed when you are going up and down hills. If your vehicle speed increases going down a hill, use the brakes to slow down. This will cancel the cruise control. To resume the set speed, press the RES/ACCEL button. The CRUISE CONTROL indicator on the instrument panel will come back on.



When climbing a steep hill, the automatic transmission may downshift to hold the set speed.

Changing the Set Speed

You can increase the set cruising speed in any of these ways:

- Press and hold the RES/ACCEL button. When you reach the desired cruising speed, release the button.
- Push on the accelerator pedal until you reach the desired cruising speed, then press the SET/DECEL button.
- To increase the speed in very small amounts, tap the RES/ACCEL button. Each time you do this, your vehicle will speed up about 1.6 km/h (1 mph).

You can decrease the set cruising speed in any of these ways:

- Press and hold the SET/DECEL button. Release the button when you reach the desired speed.
- To slow down in very small amounts, tap the SET/DECEL button. Each time you do this, your vehicle will slow down about 1.6 km/h (1 mph).
- Tap the brake or clutch pedal lightly with your foot. The CRUISE CONTROL indicator on the instrument panel will go out. When the vehicle slows to the desired speed, press the SET/DECEL button.





Cruise Control (For some types)

Even with the cruise control turned on, you can still use the accelerator pedal to speed up for passing. After completing the pass, take your foot off the accelerator pedal. The vehicle will return to the set cruising speed.

Resting your foot on the brake or clutch pedal causes the cruise control to cancel.



Cancelling Cruise Control

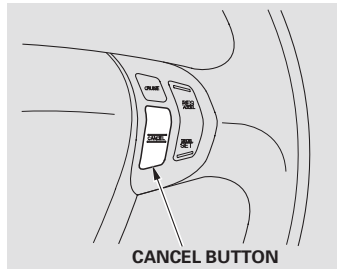

You can cancel cruise control in any of these ways:

- Tap the brake or clutch pedal.
- Push the CANCEL button on the steering wheel.
- Push the cruise control master button.

Resuming the Set Speed

When you push the CANCEL button, or tap the brake or clutch pedal, the system will remember the previously-set cruising speed. To return to that speed, accelerate to above 40 km/h (25 mph), then press and release the RES/ACCEL button. The CRUISE CONTROL indicator comes on, and the vehicle will accelerate to the same cruising speed as before. Pressing the Cruise Control Master Button turns the system completely off and the CRUISE MAIN indicator goes off, then the previous cruising speed is erased.





06/10/30 17:06:09 32SJD620_185



182





Before Driving

Before you begin driving your vehicle, you should know what fuel to use and how to check the levels of important fluids. You also need to know how to properly store luggage or packages. The information in this section will help you. If you plan to add any accessories to your vehicle, please read the information in this section first.

Break-in Period	184
Fuel Recommendation	184
Service Station Procedures	185
Refueling.....	185
Opening and Closing the Bonnet.....	186
Oil Check.....	188
Engine Coolant Check	189
Fuel Cutoff System.....	191
Fuel Economy	192
Accessories and Modifications	193
Carrying Luggage.....	195





Break-in Period, Fuel Recommendation

Break-in Period

Help assure your vehicle's future reliability and performance by paying extra attention to how you drive during the first 1,000 km (625 miles).

- Avoid full-throttle starts and rapid acceleration.
- Avoid hard braking for the first 300 km (200 miles).
- Do not change the oil until the scheduled maintenance time.
- Do not tow a trailer.

You should also follow these recommendations with an overhauled or exchanged engine, or when the brakes are replaced.

Fuel Recommendation

Petrol models

Except for New Zealand models

Your vehicle is designed to operate on Premium/Super unleaded petrol with a Research Octane Number (RON) of 95 or higher.

New Zealand models

Your vehicle is designed to operate on unleaded petrol with 91 Research Octane Number (RON) or higher.

All models

Petrol of the recommended Research Octane Number (RON) may not be available in some areas. In this case, petrol of a lower octane may be used if it does not cause engine "knocking."

Using petrol containing lead will damage your vehicle's emissions controls and engine. This contributes to air pollution.

Diesel models

Your vehicle is designed to use only Diesel Fuel (also known as Automotive gas oil and Derv).

Your vehicle is not designed to use RME (Rapeseed Methyl Ester). For more information, ask your dealer.

The quality of diesel fuel (Derv) can vary in different countries, and only clean and good quality fuel should be used.





Fuel Recommendation, Service Station Procedures

You need to use the proper fuel for EN590 and also vary the fuel depending on the season.

Select the proper fuel according to the regional or climate condition. Use of inadequate fuel may reduce engine power. In this case, the glow plugs indicator blinks.

For proper fuel selection, "DIESEL" is marked on the fuel fill cap.

NOTICE

Serious damage may occur if petrol is used in diesel engines.

Refueling

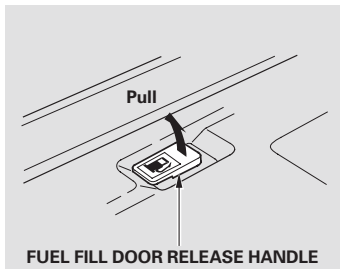

1. Park with the left side closest to the service station pump.
2. Open the fuel fill door by pulling on the handle at the outside of the driver's seat.

⚠ WARNING

Fuel is highly flammable and explosive. You can be burned or seriously injured when handling fuel.

- Stop the engine, and keep heat, sparks, and flame away.
- Handle fuel only outdoors.
- Wipe up spills immediately.

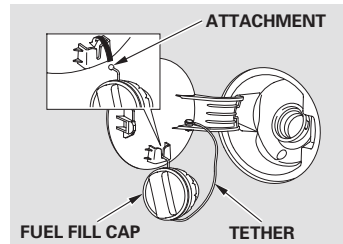

CONTINUED





Service Station Procedures

3. Remove the fuel fill cap slowly. You may hear a hissing sound as pressure inside the tank escapes.

The fuel fill cap is attached to the fuel filler with a tether. Put the attachment on the fuel fill cap into the slit on the fuel fill door.

4. Stop filling the tank after the fuel nozzle automatically clicks off. Do not try to "top off" the tank. Leave some room for the fuel to expand with temperature changes.
5. Screw the fuel fill cap back on until it clicks at least once.
6. Push the fuel fill door closed until it latches.

Opening and Closing the Bonnet

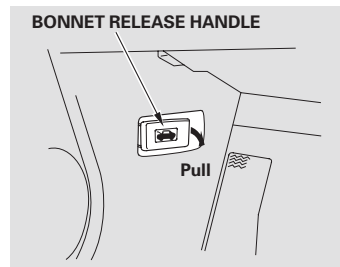

1. Park the vehicle, and set the parking brake. Pull the bonnet release handle under the lower corner of the dashboard. The bonnet will pop up slightly.



2. Put your fingers under the front edge of the bonnet near the centre. Slide your hand to the left until you feel the bonnet latch handle. Push this handle up to release it. Lift up the bonnet.





Service Station Procedures

If the bonnet latch handle moves stiffly, or if you can open the bonnet without lifting the handle, the mechanism should be cleaned and lubricated.

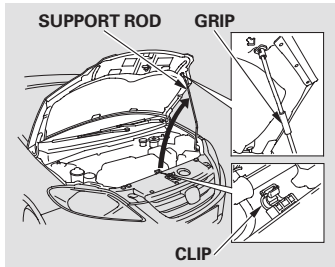

3. Holding the grip, pull the support rod out of its clip. Insert the end into the designated hole in the bonnet.

To close the bonnet, lift it up slightly to remove the support rod from the hole. Put the support rod back into its holding clip. Lower the bonnet to about 30 cm (a foot) above the fender, then let it drop. Make sure it is securely latched.





Service Station Procedures

Oil Check

All engines consume oil as part of their normal operation, therefore, the engine oil level must be checked regularly, for example when refuelling. Always check the oil before a long journey.

The amount of oil consumed depends on how the vehicle is driven and the climatic and road conditions encountered. The rate of oil consumption can be up to 1 Litre per 1,000 km/625 miles. Consumption is likely to be higher when the engine is new.

Make sure the engine is warmed up and parked on level ground. Turn off the engine and wait approximately 3 minutes before checking the oil level.

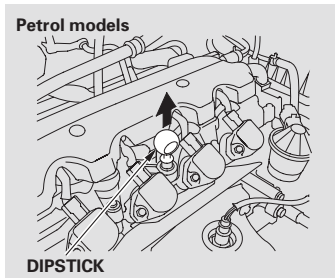

1. Remove the dipstick (orange handle).

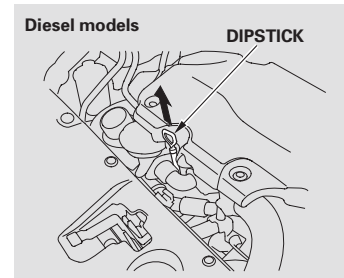

2. Wipe off the dipstick with a clean cloth or paper towel.
3. Insert it all the way back in its tube.





Service Station Procedures

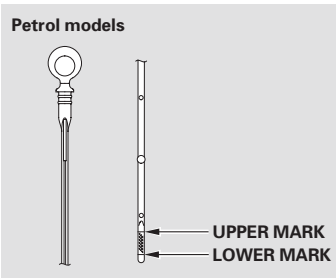

4. Remove the dipstick again, and check the level. It should be between the upper and lower marks.

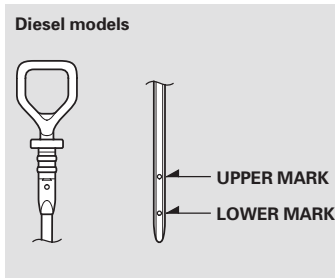

If it is near or below the lower mark, see **Adding Engine Oil** on page 239 on petrol models, 241 on diesel models.

Engine Coolant Check



On petrol models
Look at the coolant level in the radiator reserve tank. Make sure it is between the MAX and MIN lines. If it is below the MIN line, see **Adding Engine Coolant** on page 243 for information on adding the proper coolant.

CONTINUED





Service Station Procedures

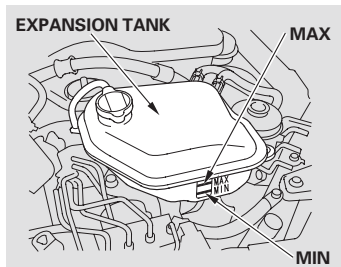

Refer to **Owner's Maintenance Checks** on page 230 for information about checking other items on your vehicle.

On diesel models
The coolant level in the expansion tank should be checked only when the engine and the cooling system are cold. Make sure it is between the MAX and MIN lines. If it is below the MIN line, see **Adding Engine Coolant** on page 246 .

190 Before Driving





Fuel Cutoff System (For some types)

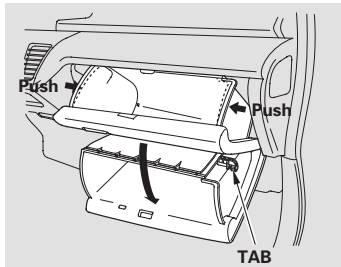

There is a fuel cutoff switch behind the glove box on the centre console side.

To locate the switch, open the glove box and disengage the two tabs by pushing on each side panel, then pivot the glove box out of the way. Extend your arm through the opened glove box.

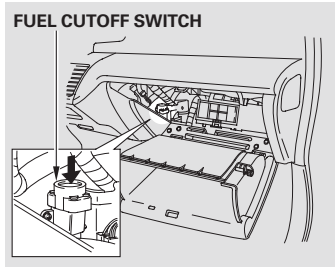

In a collision or sudden impact, this switch automatically cuts off the fuel supply to the engine.

After the switch has activated, it must be reset by pressing the button before the engine can be restarted.

⚠ WARNING

Leaking fuel can ignite or explode, causing you to be seriously or fatally injured.

Always check for fuel leaks before resetting the switch.





Fuel Economy

Improving Fuel Economy

- Always maintain your vehicle according to the maintenance schedule. See **Owner's Maintenance Checks** (see page 230).

For example, an underinflated tyre causes more "rolling resistance," which uses more fuel.

- The build-up of snow or mud on your vehicle's underside adds weight and rolling resistance. Frequent cleaning helps your fuel mileage and reduces the chance of corrosion.

- Drive moderately. Rapid acceleration, abrupt cornering, and hard braking use more fuel.
- Always drive in the highest gear possible.
- Try to maintain a constant speed. Every time you slow down and speed up, your vehicle uses extra fuel. Use the cruise control (on some types) when appropriate.
- Combine several short trips into one.
- The air conditioning puts an extra load on the engine which makes it use more fuel. Use the fresh-air ventilation when possible.





Accessories and Modifications

Modifying your vehicle, or installing some non-Honda accessories, can make your vehicle unsafe. Before you make any modifications or add any accessories, be sure to read the following information.

Accessories

Your dealer has genuine Honda accessories that allow you to personalize your vehicle. These accessories have been designed and approved for your vehicle.

Although non-Honda accessories may fit on your vehicle, they may not meet factory specifications, and could adversely affect your vehicle's handling and stability.

⚠ WARNING

Improper accessories or modifications can affect your vehicle's handling, stability, and performance, and cause a crash in which you can be hurt or killed.

Follow all instructions in this owner's manual regarding accessories and modifications.

When properly installed, cellular phones, alarms, two-way radios, and low-powered audio systems should not interfere with your vehicle's computer controlled systems, such as your airbags and anti-lock brakes.

CONTINUED

Before Driving 193





Accessories and Modifications

Before installing any accessory:

- Make sure the accessory does not obscure any lights, or interfere with proper vehicle operation or performance.
- Be sure electronic accessories do not overload electrical circuits (see page 318) or interfere with proper operation of your vehicle.
- Before installing any electronic accessory, have the installer contact your dealer for assistance. If possible, have your dealer inspect the final installation.
- Do not install accessories on the side pillars or across the rear windows. In these areas, accessories may interfere with proper operation of the side curtain airbags.

Modifying Your Vehicle

Removing parts from your vehicle, or replacing components with non-Honda components could seriously affect your vehicle's handling, stability, and reliability.

Here are some examples:

- Lowering your vehicle with a non-Honda suspension kit that significantly reduces ground clearance can allow the undercarriage to hit speed bumps or other raised objects, which could cause the airbags to deploy.
- Raising your vehicle with a non-Honda suspension kit can affect the handling and stability.
- Non-Honda wheels, because they are a universal design, can cause excessive stress on suspension components.

- Larger or smaller wheels and tyres can interfere with the operation of your vehicle's anti-lock brakes and other systems.

- Modifying your steering wheel or any other part of your vehicle's safety features can make the systems ineffective.

194 Before Driving





Carrying Luggage

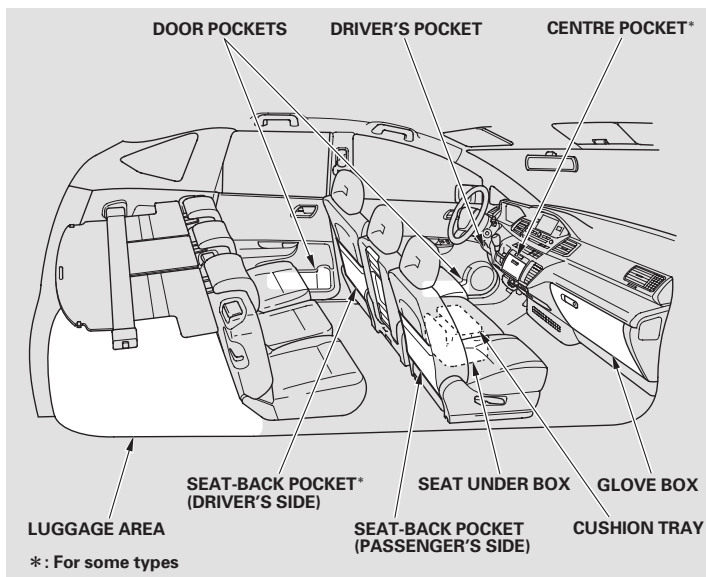

Your vehicle has several convenient storage areas:

- Glove box
- Seat-back pockets
- Luggage area, including the rear seats when folded down
- Door pockets
- Seat under box
- Cushion tray
- Driver's pocket
- Centre pocket (on some types)
- Roof-rack (if installed)

However, carrying too much luggage, or improperly storing it, can affect your vehicle's handling, stability, stopping distance, and tyres, and make it unsafe. Before carrying any type of luggage, be sure to read the following pages.





Carrying Luggage

Load Limits

When you load luggage, the total weight of the vehicle, all passengers, luggage and towbar must not exceed the maximum permissible weight. The load for the front and rear axles also must not exceed the maximum permissible axle weight. Refer to page 331 for the maximum permissible weight and maximum permissible axle weight.



⚠ WARNING

Overloading or improper loading can affect handling and stability and cause a crash in which you can be hurt or killed.

Follow all load limits and other loading guidelines in this manual.

Carrying Items in the Passenger Compartment

- Store or secure all items that could be thrown around and hurt someone during a crash.
- Do not put any items on top of the tonneau cover (for some types). They can block your view and be thrown around the vehicle during a crash.
- Be sure items placed on the floor behind the front seats cannot roll under the seats and interfere with the driver's ability to operate the pedals, and proper operation of the seats. Do not stack items higher than the back of the front seats. Do not stack items higher than the back of the front seats.
- Keep the glove box closed while driving. If it is open, a passenger could injure their knees during a crash or sudden stop.





Carrying Luggage

Carrying Luggage in the Luggage Area or on a Roof Rack

- Do not place any heavy articles on the back of the rear centre seat. It can hinder the rear centre seat from moving.
- Distribute luggage evenly on the floor of the luggage area, placing the heaviest items on the bottom and as far forward as possible. Try to secure the items with rope or cord so they will not shift while you are driving.
- If you fold down the back seat, tie down items that could be thrown about the vehicle during a crash or sudden stop. Try to secure the items with rope or cord so they will not shift while you are driving. Do not stack items higher than the back of the front seats.

Refer to page 115 for folding rear seat-back.

- If you carry large items that prevent you from closing the tailgate, exhaust gas can enter the passenger area. To avoid the possibility of **carbon monoxide poisoning**, follow the instructions on page 65 .
- If you can carry any items on a roof rack, be sure the total weight of the rack and the items does not exceed the maximum allowable weight. Please contact your dealer for further information.

If you use an accessory roof rack, the roof rack weight limit may be lower. Refer to the information that came with your roof rack.

Concerning lashing means and retaining devices offered on the accessory market, please contact your dealer.

NOTICE

A normal bike rack must not be fitted to the tailgate.





Carrying Luggage

Luggage Hooks

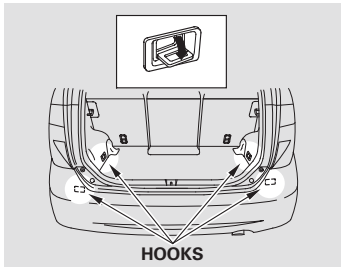

The hooks on the floor of the luggage area enable you to tie down items stored in the back. Make sure all stored items are secured before driving.



198 Before Driving





Driving

This section gives you tips on starting the engine under various conditions, and how to operate the manual transmission. It also includes important information on parking your vehicle, the braking system, and facts you need if you are planning to tow a trailer.

- Driving Guidelines..... 200
- Preparing to Drive 201
- Starting the Engine
 - Petrol models 202
 - Diesel models 203
- Manual Transmission..... 204
- Automatic Transmission..... 207
- Parking Tips 213
- Braking System..... 214
- Anti-lock Brakes (ABS) 215
- Vehicle Stability Assist (VSA)
 - System..... 217
- Driving in Bad Weather 219
- Towing a Trailer 221





Driving Guidelines

Your vehicle is designed to give you optimum handling and performance on well-maintained roads. As part of this design, your vehicle has a minimum of ground clearance.

- Use caution if you should drive your vehicle on very rough or rutted roads. You could damage the suspension and underbody by bottoming out. Going too fast over parking lot “speed bumps” can also cause damage.

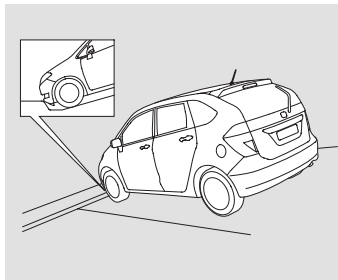

- Curbs and steep inclines could damage the front and rear bumpers. Low curbs that do not affect the average vehicle may be high enough to hit the bumper on your vehicle. The front or rear bumper may scrape when trying to drive onto an incline, such as a steep driveway or trailer ramps.





Preparing to Drive

You should do the following checks and adjustments before you drive your vehicle.

1. Make sure all windows, mirrors, and outside lights are clean and unobstructed. Remove frost, snow, or ice.
2. Check that the bonnet is fully closed.
3. Visually check the tyres. If a tyre looks low, use a gauge to check its pressure.
4. Check that any items you may be carrying are stored properly or fastened down securely.
5. Check the seat adjustment (see page 108).
6. Check the adjustment of the inside and outside mirrors (see page 126).
7. Check the steering wheel adjustment (see page 95).
8. Make sure the doors and the tailgate are securely closed.
9. Fasten your seat belt. Check that your passengers have fastened their seat belts (see page 17).
10. When you start the engine, check the gauges and indicators in the instrument panel (see page 72).





Starting the Engine (Petrol models)

1. Apply the parking brake.
2. In cold weather, turn off all electrical accessories to reduce the drain on the battery.
3. *On vehicles with manual transmission*
Push the clutch pedal down all the way and shift the transmission to neutral.

On vehicles with automatic transmission

Make sure the shift lever is in Park. Press on the brake pedal.

4. Without touching the accelerator pedal, turn the ignition key to the START (III) position. Do not hold the key in the START (III) position for more than 15 seconds at a time. If the engine does not start right away, pause for at least 10 seconds before trying again.

NOTICE

The immobilizer system protects your vehicle from theft. If an improperly-coded key (or other device) is used, the engine's fuel system is disabled. See **Immobilizer System** on page 97 .

5. If the engine does not start within 15 seconds, or starts but stalls right away, repeat step 4 with the accelerator pedal pressed halfway down. If the engine starts, release pressure on the accelerator pedal so the engine does not race.
6. If the engine fails to start, press the accelerator pedal all the way down, and hold it there while starting to clear flooding. If the engine still does not start, return to step 5.

NOTICE

The engine is harder to start in cold weather. Also, the thinner air found at altitudes above 2,400 meters (8,000 feet) adds to this problem.

If the outside temperature is below freezing, or if your vehicle has not been driven for several days, warm up the engine for a few minutes before driving (prohibited in Germany! § 30 StVO).





Starting the Engine (Diesel models)

1. Apply the parking brake.
2. Turn off all electrical accessories to reduce the drain on the battery.
3. Push the clutch pedal down all the way and shift the transmission to neutral.
4. Turn the ignition key to the ON (II) position. Wait until the glow plugs indicator turns off.
5. Without touching the accelerator pedal, turn the ignition key to the START (III) position, and release the key as soon as the engine is running. If the engine does not start right away, do not hold the key in START (III) for more than 15 seconds at a time (20 seconds in cold weather). Pause for at least 20 seconds before trying again.

NOTICE

The immobilizer system protects your vehicle from theft. If an improperly-coded key (or other device) is used, the engine's fuel system is disabled. See **Immobilizer System** on page 97 .

Cold Climates

In very cold climates the battery charging and oil pressure indicators may take several seconds to extinguish. Similarly, engine cranking times will also increase.

If you start the engine in cold weather or at high altitude, the glow plugs indicator may also remain on longer than normal operation.

Warming Up

In the interests of fuel economy, it is advisable to start driving straight away, remembering that harsh acceleration or labouring the engine before the normal operating temperature has been reached can damage the engine.

NOTICE

The engine must not be run above fast idle speed until the oil pressure warning indicator goes off. This will ensure that the engine and turbocharger bearings are properly lubricated before being run at normal driving speeds.

Ignition Switching Off

To avoid the possibility of damaging the turbocharger bearings through inadequate lubrication, ALWAYS allow the engine to idle for 10 seconds before turning off the engine.





Manual Transmission

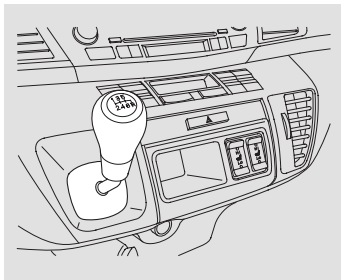

On some models
The manual transmission is synchronized in all forward gears for smooth operation. It has a lockout so you cannot accidentally shift from any forward gear to reverse while the vehicle is moving at a certain speed (see page 206).

When shifting up or down, make sure you push the clutch pedal down all the way, shift to the next gear, and let the pedal up gradually. When you are not shifting, do not rest your foot on the clutch pedal. This can cause excessive clutch wear.

Come to a full stop before you shift into reverse. You can damage the transmission by trying to shift into reverse with the vehicle moving. Push down the clutch pedal, and pause for a few seconds before shifting into reverse, or shift into one of the forward gears for a moment. This stops the gears so they won't "grind."

When slowing down, you can get extra braking from the engine by shifting to a lower gear. This extra braking can help you maintain a safe speed and prevent your brakes from overheating while going down a steep hill. Before downshifting, make sure the engine speed will not go into the tachometer's red zone in the lower gear. Refer to the maximum allowable speeds charts.

⚠ WARNING

Rapid slowing or speeding-up can cause loss of control on slippery surfaces. If you crash, you can be injured.

Use extra care when driving on slippery surfaces.





Manual Transmission

Recommended Shift Points

Drive in the highest gear that lets the engine run and accelerate smoothly. This will give you good fuel economy and effective emissions control. The following shift points are recommended:

Petrol models

Shift up	Normal acceleration
1st to 2nd	15 km/h (9 mph)
2nd to 3rd	35 km/h (22 mph)
3rd to 4th	50 km/h (31 mph)
4th to 5th	70 km/h (44 mph)
5th to 6th	100 km/h (62 mph)

Diesel models

Shift up	Normal acceleration
1st to 2nd	20 km/h (12 mph)
2nd to 3rd	40 km/h (25 mph)
3rd to 4th	55 km/h (34 mph)
4th to 5th	70 km/h (44 mph)
5th to 6th	85 km/h (53 mph)

Maximum Allowable Speeds

The speeds in this table are the maximum allowable speeds in each gear. If you exceed these speeds, the engine speed will enter into the tachometer's red zone. If this occurs, you may feel the engine cut in and out. This is caused by a limiter in the engine's computer controls. The engine will run normally when you reduce the rpm below the red zone.

Before downshifting, make sure the vehicle will not exceed the maximum allowable speed specified by the chart for the lower gear to avoid engine damage.

CONTINUED

Driving 205





Manual Transmission

Petrol models

Gear	Maximum allowable speeds
1st	50 km/h (31 mph)
2nd	93 km/h (58 mph)
3rd	135 km/h (84 mph)
4th	169 km/h (105 mph)
5th	210 km/h (130 mph)*

Diesel models

Gear	Maximum allowable speeds
1st	37 km/h (23 mph)
2nd	71 km/h (44 mph)
3rd	116 km/h (72 mph)
4th	157 km/h (98 mph)
5th	187 km/h (116 mph)*

*: The speeds in the table are calculated in relation to the engine speeds for each gear.

Reverse Lockout

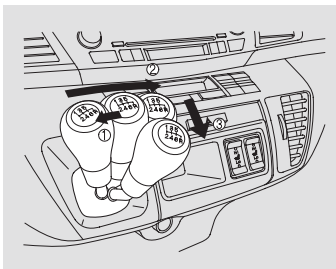

The manual transmission has lockout so you cannot accidentally shift from any forward gear to reverse while the vehicle is moving at a certain speed. If you cannot shift to reverse when the vehicle is stopped, do the following.

1. With the clutch pedal pressed, move the shift lever to the first/second gear side of the neutral gate, then shift to reverse.

2. If you are still unable to shift to reverse, apply the parking brake, and turn the ignition switch to the ACCESSORY (I) or the LOCK (0) position.
3. Press the clutch pedal, and shift to reverse.
4. With the clutch pedal still pressed, start the engine.

If you need to use this procedure to shift to reverse, your vehicle may be developing a problem. Have it checked by your dealer.

206 Driving





Automatic Transmission

Shift Lever Position Indicators

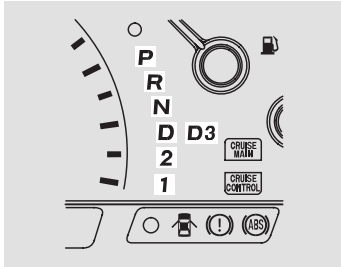

These indicators on the instrument panel show which position the shift lever is in.

The "D" indicator comes on for a few seconds when you turn the ignition switch to the ON (II) position. If it flashes while driving (in any shift position), it indicates a possible problem in the transmission.

If the malfunction indicator lamp comes on along with the "D" indicator, there is a problem with the automatic transmission control system. Avoid rapid acceleration, and have the transmission checked by your dealer as soon as possible.

Shifting

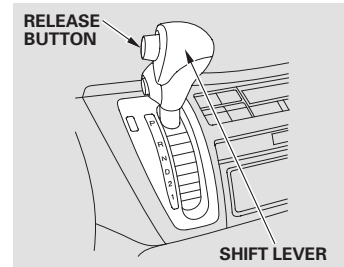

To shift from any position, press firmly on the brake pedal and press the release button on the side of the shift lever. You cannot shift out of Park when the ignition switch is in the LOCK (0) or ACCESSORY (I) position.

CONTINUED

Driving 207





Automatic Transmission

To shift from:	Do this:
P to R	Press the brake pedal and press the shift lever release button.
R to P N to R D to 2 2 to 1	Press the shift lever release button.
1 to 2 2 to D D to N N to D R to N	Move the shift lever.
D3 to D D to D3	Press the D3 button.

Park (P) – This position mechanically locks the transmission. Use Park whenever you are turning off or starting the engine. To shift out of Park, you must press on the brake pedal and have your foot off the accelerator pedal. Press the release button on the side of the shift lever to move it.

If you have done all of the above and still cannot move the lever out of Park, see **Shift Lock Release** on page 211 or 212.

To avoid transmission damage, come to a complete stop before shifting into Park. You must also press the release button to shift into Park. The shift lever must be in Park before you can remove the key from the ignition switch.

Reverse (R) – Press the brake pedal and press the release button on the side of the shift lever to shift from Park to reverse. To shift from reverse to neutral, come to a complete stop and then shift. Press the release button before shifting into reverse from neutral.

Neutral (N) – Use neutral if you need to restart a stalled engine, or if it is necessary to stop briefly with the engine idling. Shift to the Park position if you need to leave your vehicle for any reason. Press on the brake pedal when you are moving the shift lever from neutral to another gear.

Drive (D) – Use this position for your normal driving. The transmission automatically selects a suitable gear (1 through 5) for your speed and acceleration. You may notice the transmission shifting up at higher engine speeds when the engine is cold. This helps the engine warm up faster.

208 Driving





Automatic Transmission

D3 Mode

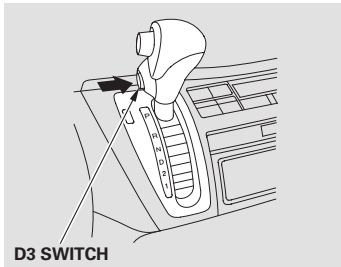

Press the D3 switch on the side of the shift lever to turn this mode on or off; the D3 mode indicator comes on whenever the D3 mode is selected.

D3 mode can be turned on or off only when the ignition switch is in the ON (II) position and the shift lever is in the D position.

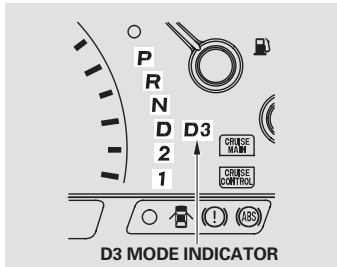

When the D3 mode is on, the transmission selects only the first three gears. Use D3 mode when towing a trailer, or to provide engine braking when going down a steep hill. D3 mode can also keep the transmission from cycling between third and fourth gears in stop-and-go driving.

Shifting out from the D position will cancel the D3 mode, and the D3 indicator will go out. Selecting the D position again will resume the D3 mode and the indicator comes on.

Turning the ignition switch to the LOCK (0) position turns this mode off. When you restart the engine, select the D position and press the D3 mode switch again to use this mode.

The D3 mode indicator also comes on for a few seconds when you turn the ignition switch to the ON (II) position.

Second (2) — To shift to second, press the release button on the side of the shift lever. This position locks the transmission in second gear. It does not downshift to first gear when you come to a stop.

CONTINUED

Driving 209





Automatic Transmission

Use second gear:

- For more power when climbing.
- To increase engine braking when going down steep hills.
- For starting out on a slippery surface or in deep snow.
- To help reduce wheel spin.
- When driving downhill with a trailer.

First (1) – To shift from second to first, press the release button on the side of the shift lever. This position locks the transmission in first gear. By upshifting and downshifting through 1, 2, and D, you can operate this transmission much like a manual transmission without a clutch pedal.

If you shift into first position when the vehicle speed is above 50 km/h (31 mph), the transmission shifts into second gear first to avoid sudden engine braking.

Maximum Allowable Speeds

The speeds in this table are the maximum allowable speeds in each position. If you exceed these speeds, the engine speed will enter into the tachometer's red zone. If this occurs, you will feel the engine cut in and out. This is caused by a limiter in the engine's computer controls. The engine will run normally when you reduce the rpm below the red zone.

Before downshifting, make sure the vehicle will not exceed the maximum allowable speed specified by the chart for the lower gear to avoid engine damage.

Position	Maximum allowable speeds
D3	156 km/h (97 mph)
2	107 km/h (66 mph)
1	61 km/h (38 mph)



210 Driving





Automatic Transmission

Shift Lock Release

For left-hand drive type

This allows you to move the shift lever out of Park if the normal method of pushing on the brake pedal and pressing the release button does not work.

1. Set the parking brake.
2. Remove the key from the ignition switch.
3. Put a cloth on the notch of the shift lock release slot cover. Using a small flat-tipped screwdriver or metal fingernail file, carefully pry on the notch of the cover to remove it.

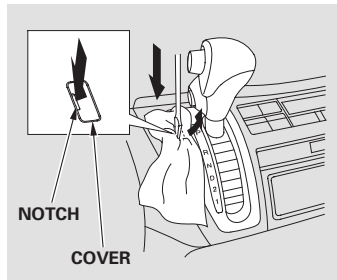

4. Insert the key in the shift lock release slot.
5. Push down on the key while you press the release button on the side of the shift lever and move it out of Park to neutral.

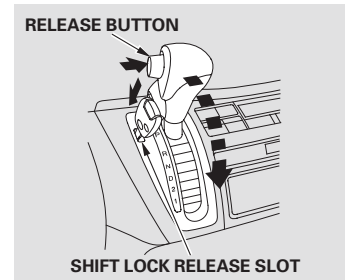

6. Remove the key from the shift lock release slot, then reinstall the cover. Make sure the notch on the cover is on the driver's side. Press the brake pedal, and restart the engine.

If you need to use the shift lock release, it means your vehicle is developing a problem. Have the vehicle checked by your dealer.





Automatic Transmission

Shift Lock Release

For right-hand drive type

This allows you to move the shift lever out of Park if the normal method of pushing on the brake pedal and pressing the release button does not work.

1. Set the parking brake.
2. Remove the key from the ignition switch.
3. Put a cloth on the notch of the shift lock release slot cover. Using a small flat-tipped screwdriver or metal fingernail file, carefully pry on the notch of the cover to remove it.

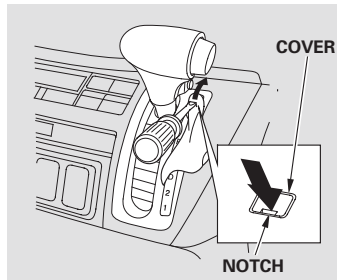

4. Insert the key in the shift lock release slot.
5. Push down on the key while you press the release button on the side of the shift lever and move it out of Park to neutral.

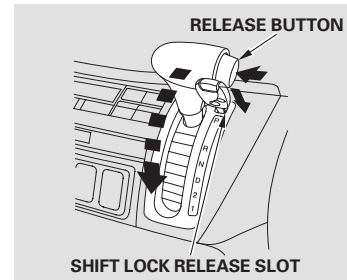

6. Remove the key from the shift lock release slot, then reinstall the cover. Make sure the notch on the cover is rearward. Press the brake pedal, and restart the engine.

If you need to use the shift lock release, it means your vehicle is developing a problem. Have the vehicle checked by your dealer.





Parking Tips

Always use the parking brake when you park your vehicle. Make sure the parking brake is set firmly, or your vehicle may roll if it is parked on an incline.

On vehicles with automatic transmission
Set the parking brake before you put the transmission in Park. This keeps the vehicle from moving and putting pressure on the parking mechanism in the transmission.

Parking Tips

- Make sure the sunroof (if equipped) and the windows are closed.
- Turn off the lights.
- Place any packages, valuables, etc., in the luggage area or take them with you.
- Lock the doors with the key or the remote transmitter.

On vehicles with security system
Check the indicator on the instrument panel to verify that the security system is set.

- Never park over dry leaves, tall grass, or other flammable materials. The hot three way catalytic converter could cause these materials to catch on fire.

- If the vehicle is facing uphill, turn the front wheels away from the curb. If your vehicle has a manual transmission, put it in first gear.
- If the vehicle is facing downhill, turn the front wheels toward the curb. If your vehicle has a manual transmission, put it in reverse gear.
- Make sure the parking brake is fully released before driving away. Driving with the parking brake partially set can overheat or damage the rear brakes.





Braking System

Your vehicle is equipped with disc brakes at all four wheels. A power assist helps reduce the effort needed on the brake pedal. The anti-lock brake system (ABS) helps you retain steering control when braking very hard.

Resting your foot on the brake pedal applied the brakes slightly. This builds up heat, and reduces brake effectiveness and brake pad life. In addition, fuel economy can be reduced. It also keeps your brake lights on all the time, confusing drivers behind you.

Constant application of the brakes when going down a long hill builds up heat and reduces their effectiveness. Use the engine to assist the brakes by taking your foot off the accelerator and downshifting to a lower gear.

Check your brakes after driving through deep water. Apply the brakes moderately to see if they feel normal. If not, apply them gently and frequently until they do. Be extra cautious and alert in your driving.

Braking System Design

The hydraulic system that operates the brakes has two separate circuits. Each circuit works diagonally across the vehicle (the left-front brake is connected with the right-rear brake, etc.). If one circuit should develop a problem, you will still have braking at two wheels.

Brake Wear Indicators

All four brakes have audible brake wear indicators.

If the brake pads need replacing, you will hear a distinctive, metallic screeching sound when you apply the brake pedal. If you do not have the brake pads replaced, they will screech all the time. It is normal for the brakes to occasionally squeal or squeak when you apply them.





Anti-lock Brakes (ABS)

The anti-lock brake system (ABS) helps prevent the wheels from locking up, and helps you retain steering control by pumping the brakes rapidly, much faster than a person can do it.

The electronic brake distribution (EBD) system, which is part of the ABS, also balances the front-to-rear braking distribution according to vehicle loading.

You should never pump the brake pedal. Let the ABS work for you by always keeping firm, steady pressure on the brake pedal. This is sometimes referred to as “stomp and steer.”

Activating the Anti-lock Brakes

You will feel a pulsation in the brake pedal when the ABS activates, and you may hear some noise. This is normal: it is the ABS rapidly pumping the brakes. On dry pavement, you will need to press on the brake pedal very hard before the ABS activates. However, you may feel the ABS activate immediately if you are trying to stop on snow or ice.



ABS Indicator

If this indicator comes on, the anti-lock function of the braking system has shut down. The brakes still work like a conventional system, but without anti-lock. You should have your dealer inspect your vehicle as soon as possible.

If the ABS indicator and the brake system indicator come on together, and the parking brake is fully released, the EBD system may also be shut down.

CONTINUED

Driving **215**





Anti-lock Brakes (ABS)

Test your brakes as instructed on page 317. If the brakes feel normal, drive slowly and have your vehicle repaired by your dealer as soon as possible. Avoid sudden hard braking which could cause the rear wheels to lock up and possibly lead to a loss of control.

The VSA indicator will come on along with the ABS indicator.

Important Safety Reminders
ABS does not reduce the time or distance it takes to stop the vehicle. It only helps with the steering control during braking.

ABS will not prevent a skid that results from changing direction abruptly, such as trying to take a corner too fast or making a sudden lane change. Always drive at a safe speed for the road and weather conditions.

ABS cannot prevent the loss of stability. Always steer moderately when you are braking hard. Severe or sharp steering wheel movement can still cause your vehicle to veer into oncoming traffic or off the road.

A vehicle with ABS may require a longer distance to stop on loose or uneven surfaces, such as gravel or snow, than a vehicle without anti-lock.





Vehicle Stability Assist (VSA) System

The vehicle stability assist (VSA) system helps to stabilize the vehicle during cornering if the vehicle turns more or less than desired. It also assists you in maintaining traction while accelerating on loose or slippery road surfaces. It does this by regulating the engine's output, and by selectively applying the brakes.

When VSA activates, you may notice that the engine does not respond to the accelerator in the same way it does at other times. You will also see the VSA activation indicator blink.

The VSA system cannot enhance the vehicle's driving stability in all situations and does not control your vehicle's entire braking system. It is still your responsibility to drive and corner at reasonable speeds and to leave a sufficient margin of safety.



VSA Activation Indicator

When VSA activates, you will see the VSA activation indicator blink.



VSA System Indicator

The VSA system indicator (see page 78) comes on and stays on when there is a problem with the VSA system. The VSA activation indicator will also come on.

If this indicator comes on while driving, pull to the side of the road when it is safe, and turn off the engine. Reset the system by restarting the engine. If the VSA system indicator stays on, or comes back on while driving, have the VSA system inspected by your dealer.

If the indicator does not come on when the ignition switch is turned to the ON (II) position, there may be a problem with the VSA system. Have your dealer inspect your vehicle as soon as possible.

Without VSA, your vehicle will have normal braking and cornering ability, but it will not have VSA traction and stability enhancement.





Vehicle Stability Assist (VSA) System

VSA Off Switch

In certain unusual conditions when your vehicle gets stuck in shallow mud or fresh snow, it may be easier to free it with the VSA temporarily switched off. When the VSA system is off, the traction control system is also off. You should only attempt to free your vehicle with the VSA off if you are not able to free it when the VSA is on.

Immediately after freeing your vehicle, be sure to switch the VSA on again. We do not recommend driving your vehicle with the VSA and traction control systems switched off.

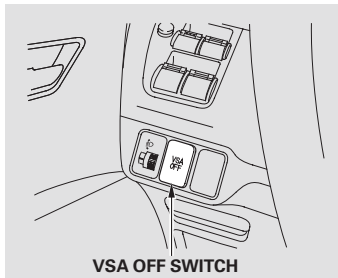

This switch is under the power window switch. To turn the VSA system on and off, press and hold it until you hear a beep.

When VSA is off, the VSA activation indicator comes on as a reminder.

VSA is turned on every time you start the engine, even if you turned it off the last time you drove the vehicle.

VSA and Tyre Sizes

Driving with varying tyre or wheel sizes may cause the VSA to malfunction. When replacing tyres, make sure they are of the same size and type as your original tyres (see page 278).

If you install winter tyres, make sure they are the same size as those that were originally supplied with your vehicle. Exercise the same caution during winter driving as you would if your vehicle was not equipped with VSA.





Driving in Bad Weather

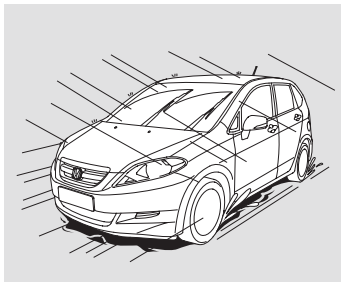

Rain, fog, and snow conditions require a different driving technique because of reduced traction and visibility. Keep your vehicle well-maintained and exercise greater caution when you need to drive in bad weather. The cruise control (on some types) should not be used in these conditions.

Driving Technique — Always drive slower than you would in dry weather. It takes your vehicle longer to react, even in conditions that may seem just barely damp. Apply smooth, even pressure to all the controls. Abrupt steering wheel movements or sudden, hard application of the brakes can cause loss of control in wet weather. Be extra cautious for the first few kilometers (miles) of driving while you adjust to the change in driving conditions. This is especially true in snow. A person can forget some snow-driving techniques during the summer months. Practice is needed to relearn those skills.

Exercise extra caution when driving in rain after a long dry spell. After months of dry weather, the first rains bring oil to the surface of the roadway, making it slippery.

Visibility — Being able to see clearly in all directions and being visible to other drivers are important in all weather conditions. This is more difficult in bad weather. To be seen more clearly during daylight hours, turn on your headlights.

Inspect your windscreen wipers and washers frequently. Keep the windscreen washer reservoir full of the proper fluid. Have the windscreen wiper blades replaced if they start to streak the windscreen or leave parts unwiped. Use the demister and air conditioning to keep the windows from fogging up on the inside (see pages 94 and 145).



CONTINUED

Driving 219





Driving in Bad Weather

Traction — Check your tyres frequently for wear and proper pressure. Both are important in preventing “aquaplaning” (loss of traction on a wet surface). In the winter, mount snow tyres on all four wheels for the best handling.

Watch road conditions carefully, they can change from moment to moment. Wet leaves can be as slippery as ice. “Clear” roads can have patches of ice. Driving conditions can be very hazardous when the outside temperature is near freezing. The road surface can become covered with areas of water puddles mixed with areas of ice, so your traction can change without warning.

Be careful when downshifting. If traction is low, you can lock up the drive wheels for a moment and cause a skid.

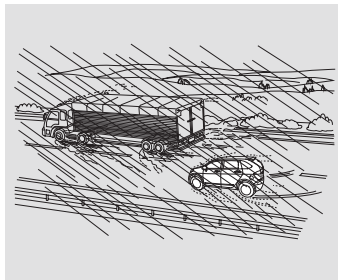

Be very cautious when passing, or being passed by other vehicles. The spray from large vehicles reduces your visibility, and the wind buffeting can cause you to lose control.

CAUTION: *Do not drive on the road where water is deep. Driving through deep water will cause damage to the engine and electrical equipment and the vehicle will break down.*





Towing a Trailer

Your vehicle has been designed primarily to carry passengers and their luggage. You can also use it to tow a trailer if you carefully observe the load limits, use the proper equipment, and follow the guidelines in this section.

⚠ WARNING

Exceeding any load limit or improperly loading your vehicle and trailer can cause a crash in which you can be seriously hurt or killed.

Check the loading of your vehicle and trailer carefully before starting to drive.

Load Limits

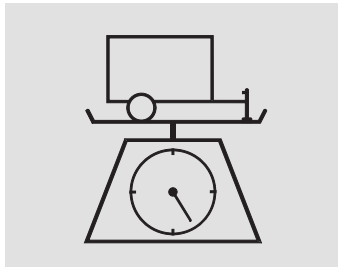

- The total weight of the trailer and towbar (with/without brakes) plus its luggage must not exceed the maximum towing weight. See page 331 .

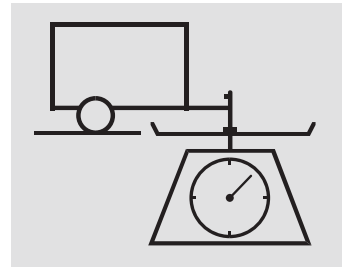

- The “trailer nose load” should never exceed 90 kg (198 lbs). This is the amount of weight the trailer puts on the towbar when it is fully-loaded. As a rule of thumb for trailer weight of less than 500 kg (1,102 lbs), the trailer nose load should be 10 percent of the total trailer package.

CONTINUED

Driving 221





Towing a Trailer

For example, if the trailer and its load weigh 225 kg (500 lbs), the trailer nose load should be 22.5 kg (50 lbs). Adjust trailer's luggage to change the trailer nose load. Start by putting approximately 60 percent of the luggage toward the front and 40 percent toward the rear. With a trailer package of more than 500 kg (1,102 lbs), you may need to adjust the luggage weight toward the rear. Never load the trailer so the back is heavier than the front. This takes weight off your vehicle's rear axle and reduces traction.

- The maximum permissible weight must not exceed the specified limit as shown on page 331 .
- The maximum permissible weight is total weight of the vehicle, driver, passengers, luggage and towbar.

- Please consider that the installation of optionals (and trailer nose load when towing a trailer) will reduce the loading capacity.
- The maximum towing weight must not exceed the specified limit as shown on page 331 .

This weight will be estimated on normal driving below 1,000 meters elevation.

If you tow a trailer in mountainous conditions, remember to reduce 10% of the combined vehicle and trailer weights from the maximum towing weight for every 1,000 meters of elevation.

The combined vehicle and trailer weights are the maximum permissible weight and trailer weight with everything in and on the trailer.

Towing a load that is too heavy can seriously affect your vehicle's handling and performance. It can also damage the engine and drivetrain.

Checking Loads

The best way to confirm that vehicle and trailer weights are within limits is to have them checked at a public scale.

Using a suitable scale or a special trailer nose load gauge, check the total weight, the weight at each axle and the trailer nose load the first time you set up a towing combination (a fully-loaded vehicle and trailer), then recheck the loads whenever the conditions change.



222 Driving





Towing a Trailer

Towing Equipment and Accessories

Towing can require a variety of equipment, depending on the size of your trailer, how it will be used, how much load you are towing, and where you tow.

Discuss any additional needs with your trailer sales or rental agency, and make sure all equipment is properly installed, maintained, and also meets the country's regulations where you are driving.

Safety Chains

Always use safety chains when you tow a trailer. Make sure the chains are secured to the trailer and towbar, and that they cross under the trailer nose and can catch the trailer if it becomes unhitched. Leave enough slack to allow the trailer to turn corners easily, but do not let the chains drag on the ground.

Towbars

Any towbar used on your vehicle must be properly bolted to the underbody.

Refer to page 330 for the towbar mounting points.

Trailer Brakes

If you are thinking of getting a trailer that has brakes, be sure they are electronically actuated. Do not attempt to tap into your vehicle's hydraulic system. No matter how successful it may seem, any attempt to attach trailer brakes to your vehicle's hydraulic system will lower braking effectiveness and create a potential hazard.

See your trailer dealer or rental agency for more information on installing electric brakes.

Trailer Lights

Trailer lights and equipment must comply with the country's regulations where you are driving. Check the requirements for the areas where you plan to tow, and use only equipment designed for your vehicle.

Your vehicle has a connector to install an optional trailer lighting connector. It is located in the luggage area by the right tail-lights. You can get an optional trailer lighting connector for your vehicle from your dealer.

Since lighting and wiring vary by trailer type and brand, you should have a qualified technician install a suitable connector between the vehicle and the trailer. Improper equipment or installation can cause damage to your vehicle's electrical system.

CONTINUED

Driving 223





Towing a Trailer

Always consult your dealer before connecting the trailer lights to your vehicle's lighting system.

Additional Towing Equipment

There may be laws requiring special outside mirrors when towing a trailer. Check the local laws in the country. Even if there are no legal requirements, you should install special mirrors if you cannot clearly see behind you, or if the trailer creates a blind spot.

Ask your trailer sales or rental agency if any other items are recommended or required for your towing situation.

Pre-Tow Checklist

When preparing to tow, and before driving away, be sure to check the following:

- The vehicle has been properly serviced, and the suspension, cooling system, and lights are in good operating condition.
- The trailer has been properly serviced and is in good condition.
- All weights and loads are within limits.
- The towbar, safety chains, and any other attachments are secure.
- All items in or on the trailer are properly secured and cannot shift while you drive.

- The lights and brakes on your vehicle and the trailer are working properly.

- Your vehicle tyres and spare are properly inflated, and the trailer tyres and spare are inflated as recommended by the trailer maker.

- Be sure to check regulations concerning the maximum speed or driving restrictions for vehicles towing trailers. If you are driving across several countries, check each country's requirements before leaving home, because regulations may vary.

Operating speed when towing a trailer is restricted to 100 km/h (62 mph).





Towing a Trailer

Driving Safely With a Trailer

The added weight, length, and height of a trailer will affect your vehicle's handling and performance, so driving with a trailer requires some special driving skills and techniques.

For your safety and the safety of others, take time to practice driving manoeuvre before heading for the open road, and follow the guidelines below.



Towing Speeds and Gears

Drive slower than normal in all driving situations, and obey posted speed limits for vehicles with trailers.

If your vehicle has an automatic transmission, use the D position when towing a trailer on level roads. D3 is the proper shift lever position to use when towing a trailer in hilly terrain.

Do not exceed the limited speed when towing a trailer. At higher speeds, the trailer may sway or affect vehicle handling (see "**Driving on Hills**" in the next page for additional gear information).

Handling Crosswinds and Buffeting

Crosswinds and air turbulence caused by passing trucks can disrupt your steering and cause the trailer to sway. When being passed by a large vehicle, keep a constant speed, and steer straight ahead. Do not try to make quick steering or braking corrections.

Backing Up

Always drive slowly and have someone guide you when backing up. Grip the *bottom* of the steering wheel; then turn the wheel to the left to get the trailer to move to the left, and turn the wheel right to move the trailer to the right.



CONTINUED

Driving **225**





Towing a Trailer

Parking

Follow all normal precautions when parking, including firmly setting the parking brake and putting the transmission in Park (automatic) or in first or reverse (manual). Also, place wheel chocks at each of the trailer's tyres.

On diesel models only

You should keep the engine idling for about 2 minutes before turning off the ignition switch. (Idling the engine is prohibited in some countries. Always follow the legal requirements of the countries in which you will drive.)

Making Turns and Braking

Make turns more slowly and wider than normal. The trailer tracks a smaller arc than your vehicle, and it can hit or run over something the vehicle misses. Allow more time and distance for braking. Do not brake or turn suddenly as this could cause the trailer to jackknife or turn over.

Driving on Hills

When climbing hills, closely watch your temperature gauge. If it nears the red (Hot) mark, turn the air conditioning off, reduce speed and, if necessary, pull to the side of the road to let the engine cool.

On vehicles with manual transmission

When driving down hills, reduce your speed, and shift down to second gear. Do not "ride" the brakes, and remember, it will take longer to slow down and stop when towing a trailer.

On vehicles with automatic transmission

When driving down hills, reduce your speed and use the D3 position. Do not "ride" the brakes, and remember it will take longer to slow down and stop when towing a trailer.

If you must stop when facing uphill, use the foot brake or parking brake. Do not try to hold the vehicle in place by pressing on the accelerator, as this can cause the automatic transmission to overheat.

Driving on an uphill road of more than 12% slope is not recommended for your vehicle.

We recommend that you tow a trailer on the roads recommended by the trailer association.





Maintenance

Regularly maintaining your vehicle is the best way to protect your investment. You will be rewarded with safer, more economical, trouble-free driving. This section lists items that need to be checked regularly and explains how to check them. It also details some simple maintenance tasks you can do yourself. The maintenance schedules show you when these things need to be done.

Maintenance Safety.....	228
Maintenance Schedule.....	229
Petrol models	231
Diesel models.....	234
Maintenance Record	236
Fluid Locations.....	237
Adding Engine Oil	
Petrol models	239
Diesel models.....	241
Engine Coolant	
Petrol models	243
Diesel models.....	246
Windscreen Washers	248
Manual Transmission Fluid	249
Automatic Transmission Fluid....	249
Brake and Clutch Fluid.....	250
Power Steering Fluid.....	252
Air Cleaner Element.....	253
Fuel Filter	255
Lights	256
Air Conditioning System.....	270
Wiper Blades.....	271
Tyres	274
Checking the Battery	281
Vehicle Storage.....	283
Priming the Fuel System	284





Maintenance Safety

All service items not detailed in this section should be performed by a certified technician or other qualified technician.

Important Safety Precautions

To eliminate potential hazards, read the instructions before you begin, and make sure you have the tools and skills required.

- Make sure your vehicle is parked on level ground, the parking brake is set, and the engine is off.
- To clean parts, use a commercially available degreaser or parts cleaner, not fuel.
- To reduce the possibility of fire or explosion, keep cigarettes, sparks, and flames away from the battery and all fuel-related parts.
- Wear eye protection and protective clothing when working with the battery or compressed air.

⚠ WARNING

Improperly maintaining this vehicle or failing to correct a problem before driving can cause a crash in which you can be seriously hurt or killed.

Always follow the inspection and maintenance recommendations and schedules in this owner's manual/Service Book.

Potential Vehicle Hazards

- **Carbon Monoxide poison from engine exhaust.** Be sure there is adequate ventilation whenever you operate the engine.
- **Burns from hot parts.** Let the engine and exhaust system cool down before touching any parts.

- **Injury from moving parts.** Do not run the engine unless instructed to do so.

⚠ WARNING

Failure to properly follow maintenance instructions and precautions can cause you to be seriously hurt or killed.

Always follow the procedures and precautions in this owner's manual.

Some of the most important safety precautions are given here. However, we cannot warn you of every conceivable hazard that can arise in performing maintenance. Only you can decide whether or not you should perform a given task.





Maintenance Schedule

The required maintenance schedule specifies all maintenance required to keep your vehicle in peak operating condition. Maintenance work should be performed in accordance with the standards and specifications of Honda by properly trained and equipped technicians. Your authorized dealer meets all of these requirements.

There are two types of maintenance schedule in this owner's manual. One is for petrol models (see pages 231 to 233), and the other is for diesel models (see pages 234 – 235).

In EU countries, follow the maintenance schedule in the Service Book that came with your vehicle.

In New Zealand, follow the maintenance schedule in the service maintenance and warranty book that came with your vehicle.

The maintenance schedule assumes you will use your vehicle as normal transportation for passengers and their possessions. You should also follow these recommendations:

- Avoid exceeding your vehicle's load limit. This puts excess stress on the engine, brakes, and many other vehicle parts.
- Operate your vehicle on reasonable roads within the legal speed limit.
- Drive your vehicle regularly over a distance of several kilometres (miles).
- *On petrol models*
Always use the recommended petrol only (see page 184).
- *On diesel models*
Always use the recommended diesel fuel only (see page 184).

We recommend the use of genuine Honda parts and fluids or their equivalent whenever you have maintenance done. These are the same high-quality items that went into your vehicle when it was new, so you can be sure they fit and perform flawlessly.

NOTICE

On diesel models only
Do not press the engine cover forcibly. This may damage the engine cover and component parts.





Maintenance Schedule

Owner's Maintenance Checks

You should check the following items at the use or specified intervals.

- Engine oil level – Check every time you fill the fuel tank. See page 188 .
- Engine coolant level –
On petrol models
Check the radiator reserve tank every time you fill the fuel tank. See page 189 .
On diesel models
Check the expansion tank every time you fill the fuel tank. See page 190 .
- Windscreen washer fluid – Check the level in the reservoir monthly. If weather conditions cause you to use the washers frequently, check the reservoir each time you stop for fuel. See page 248 .

- Windscreen wipers – Check the wiper condition monthly. If the wipers do not wipe the windscreen securely, check them for wear, cracks, and other damage.
- Brakes and clutch – Check the fluid level monthly. See page 250 .
- Brake pedal – Check the brake pedal for smooth operation.
- Parking brake – Check the parking brake handle for smooth operation.
- Tyres – Check the tyre pressure monthly. Examine the tread for wear and foreign objects. See page 274 .

- Battery – Check its condition and the terminals for corrosion monthly. See page 281 .
- Air conditioning system – Check its operation weekly. See page 270 .
- Windscreen demister – Operate the heater and air conditioning and check the demister vents monthly.
- Lights – Check the operation of the headlights, position lights, tail-lights, high-mount brake light, turn signals, and licence plate lights monthly. See page 256 .
- Doors – Check the tailgate and all doors including the rear doors for smooth opening/closing and secure locking.
- Horn – Check the horn operation.

230 Maintenance





Maintenance Schedule for Petrol Models (Except EU and New Zealand)

Service at the indicated distance or time — whichever comes first.	km x 1,000	20	40	60	80	100	120	140	160	180	200	
	miles x 1,000	12.5	25.0	37.5	50.0	62.5	75.0	87.5	100.0	112.5	125.0	
	months	12	24	36	48	60	72	84	96	108	120	
Replace engine oil* ¹	Normal	Every 10,000 km (6,250 miles) or 1 year										
	Severe* ²	Every 5,000 km (3,125 miles) or 6 months										
Replace engine oil filter* ¹	Normal	•	•	•	•	•	•	•	•	•	•	
	Severe* ²	Every 10,000 km (6,250 miles) or 6 months										
Clean air cleaner element	Dry type only	Every 10,000 km (6,250 miles)										
Replace air cleaner element	Dry type	Every 20,000 km (12,500 miles)										
	Wet type	Every 20,000 km (12,500 miles)										
Inspect valve clearance					•					•		
Replace fuel filter* ³					•					•		
Replace spark plugs		Every 100,000 km (62,500 miles)										
Inspect drive belt		•		•		•		•		•		
Inspect idle speed						•					•	
Replace engine coolant		At 200,000 km (120,000 miles) or 10 years, thereafter every 100,000 km (60,000 miles) or 5 years										

This maintenance schedule outlines the minimum required maintenance that you should perform to ensure the trouble-free operation of your vehicle. Due to regional and climatic differences, some additional servicing may be required. Please consult your warranty booklet for a more detailed description.

- * 1 : Only severe schedule is required in some countries: refer to the local warranty booklet that came with your vehicle.
 * 2 : Refer to page 233 for replacement information under severe conditions.
 * 3 : Refer to page 255 for replacement information under severe driving conditions.

CONTINUED

Maintenance 231



Maintenance Schedule for Petrol Models (Except EU and New Zealand)

Service at the indicated distance or time — whichever comes first.	km x 1,000	20	40	60	80	100	120	140	160	180	200	
	miles x 1,000	12.5	25.0	37.5	50.0	62.5	75.0	87.5	100.0	112.5	125.0	
	months	12	24	36	48	60	72	84	96	108	120	
Replace transmission fluid	MT	Normal					•					
		Severe* ¹			•					•		
	AT	Normal						•				•
		Severe* ¹			•		•		•		•	
Inspect front and rear brakes	Every 10,000 km (6,250 miles) or 6 months											
Replace brake fluid	Every 3 years (independent of distance)											
Check parking brake adjustment		•	•		•		•		•		•	
Replace dust and pollen filter (if equipped)		•	•	•	•	•	•	•	•	•	•	
Rotate tyres (Check tyre inflation and condition at least once per month)	Rotate tyres every 10,000 km (6,250 miles)											
Visually inspect the following items:												
Tie rod ends, steering gear box and boots	Every 10,000 km (6,250 miles) or 6 months											
Suspension components												
Driveshaft boots												
Brake hoses and lines (including ABS)		•	•	•	•	•	•	•	•	•	•	
All fluid levels and condition of fluids		•	•	•	•	•	•	•	•	•	•	
Exhaust system												
Fuel lines and connections												

* 1 : Refer to page 233 for replacement information under severe conditions.



Maintenance Schedule for Petrol Models (Except EU and New Zealand)

NOTE:

If you drive your vehicle under one or more of the following severe conditions, the following items must be serviced according to the maintenance schedule indicated as Severe.

Severe driving conditions:

- A: Driving less than 8 km (5 miles) per trip, or in freezing temperatures, driving less than 16 km (10 miles) per trip.
- B: Driving in extremely hot [over 35°C (95°F)] conditions.
- C: Extensive idling or long periods of stop-and-go driving.
- D: Trailer towing (if applicable), driving with a loaded roof rack, or driving in mountainous conditions.
- E: Driving on muddy, dusty, or de-iced roads.



Items	Condition
Engine oil and oil filter	A, B, C, D, E
Transmission fluid	B, D



Maintenance Schedule for Diesel Models (Except EU)

Service at the indicated distance or time – whichever comes first.	km x 1,000	20	40	60	80	100	120	140	160	180	200
	miles x 1,000	12.5	25.0	37.5	50.0	62.5	75.0	87.5	100.0	112.5	125.0
	months	12	24	36	48	60	72	84	96	108	120
Replace engine oil and oil filter ^{*1}	Normal	Every 10,000 km (6,250 miles) or 1 year									
	Severe ^{*2}	Every 5,000 km (3,125 miles) or 6 months									
Replace air cleaner element (wet type)	Normal	Every 20,000 km (12,500 miles)									
	Severe ^{*2}	Every 10,000 km (6,250 miles)									
Replace fuel filter		•	•	•	•	•	•	•	•	•	•
Inspect drive belt			•		•		•		•		•
Replace engine coolant						•			•		
Replace manual transmission fluid	Normal						•				
	Severe ^{*2}			•							•
Inspect front and rear brakes		Every 10,000 km (6,250 miles) or 6 months									
Replace brake fluid		Every 3 years (independent of distance)									
Check parking brake adjustment		•	•		•		•		•		•
Replace dust and pollen filter (if equipped)		•	•	•	•	•	•	•	•	•	•
Rotate tyres (Check tyre inflation and condition at least once per month)		Rotate tyres every 10,000 km (6,250 miles)									
Visually inspect the following items:											
Tie rod ends, steering gear box and boots		Every 10,000 km (6,250 miles) or 6 months									
Suspension components		Every 10,000 km (6,250 miles) or 6 months									
Driveshaft boots		Every 10,000 km (6,250 miles) or 6 months									
Brake hoses and lines (including ABS)		•	•	•	•	•	•	•	•	•	•
All fluid levels and condition of fluids		•	•	•	•	•	•	•	•	•	•
Exhaust system		•	•	•	•	•	•	•	•	•	•
Fuel lines and connections		•	•	•	•	•	•	•	•	•	•

* 1 : Only severe schedule is required in some countries: refer to the local warranty booklet that came with your vehicle.

* 2 : Refer to page 235 for replacement information under severe conditions.

This maintenance schedule outlines the minimum required maintenance that you should perform to ensure the trouble-free operation of your vehicle. Due to regional and climatic differences, some additional servicing may be required. Please consult your warranty booklet for a more detailed description.



Maintenance Schedule for Diesel Models (Except EU)

NOTE:

If you drive your vehicle under one or more of the following severe conditions, the following items must be serviced according to the maintenance schedule indicated as Severe.

Severe driving conditions:

- A: Driving less than 8 km (5 miles) per trip, or in freezing temperatures, driving less than 16 km (10 miles) per trip.
- B: Driving in extremely hot [over 35°C (95°F)] conditions.
- C: Extensive idling or long periods of stop-and-go driving.
- D: Trailer towing (if applicable), driving with a loaded roof rack, or driving in mountainous conditions.
- E: Driving on muddy, dusty, or de-iced roads.



Items	Condition
Engine oil and oil filter	A, B, C, D, E
Air cleaner element	D, E
Manual transmission fluid	B, D





Maintenance Record (Except EU and New Zealand)

Have your servicing dealer record all required maintenance below. Keep receipts for all work done on your vehicle.

20,000 km 12,500 Mi. (or 12 Mo.)	(Sign or Stamp)	Km (Mi.) or Month Date	120,000 km 75,000 Mi. (or 72 Mo.)	(Sign or Stamp)	Km (Mi.) or Month Date
40,000 km 25,000 Mi. (or 24 Mo.)	(Sign or Stamp)	Km (Mi.) or Month Date	140,000 km 87,500 Mi. (or 84 Mo.)	(Sign or Stamp)	Km (Mi.) or Month Date
60,000 km 37,500 Mi. (or 36 Mo.)	(Sign or Stamp)	Km (Mi.) or Month Date	160,000 km 100,000 Mi. (or 96 Mo.)	(Sign or Stamp)	Km (Mi.) or Month Date
80,000 km 50,000 Mi. (or 48 Mo.)	(Sign or Stamp)	Km (Mi.) or Month Date	180,000 km 112,500 Mi. (or 108 Mo.)	(Sign or Stamp)	Km (Mi.) or Month Date
100,000 km 62,500 Mi. (or 60 Mo.)	(Sign or Stamp)	Km (Mi.) or Month Date	200,000 km 125,000 Mi. (or 120 Mo.)	(Sign or Stamp)	Km (Mi.) or Month Date

236 Maintenance





Fluid Locations

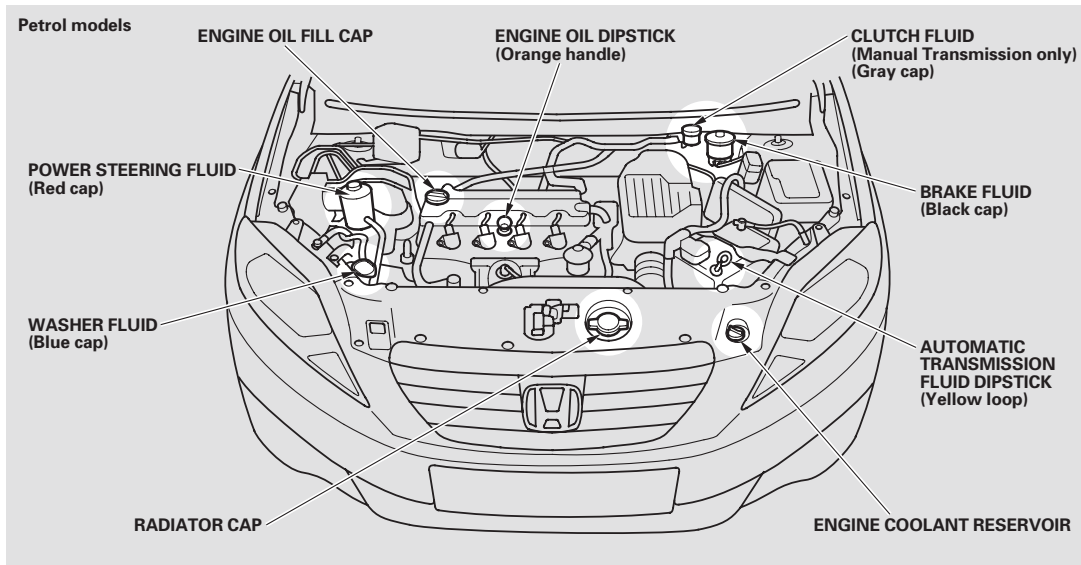

CONTINUED





Fluid Locations

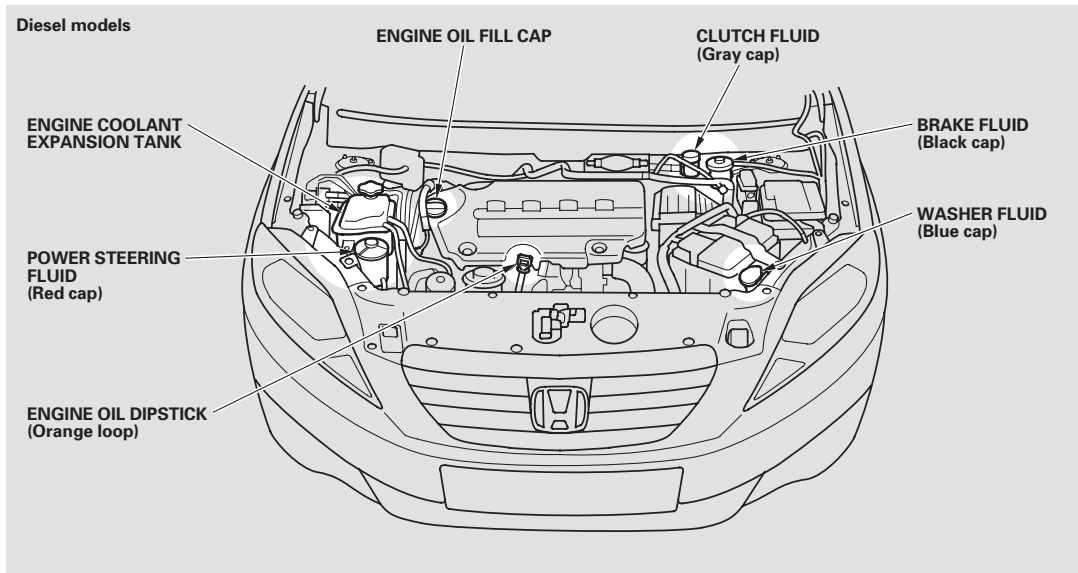



Adding Engine Oil (Petrol models)

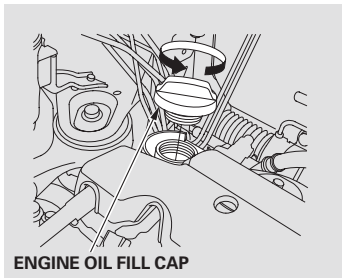

ENGINE OIL FILL CAP

Unscrew and remove the engine oil fill cap on the valve cover. Pour in the oil slowly and carefully so you do not spill any. Clean up any spills immediately. Spilled oil could damage components in the engine compartment.

Reinstall the engine oil fill cap, and tighten it securely. Let the engine warm up and turn off the engine, let it sit for approximately 3 minutes, then check the oil level on the engine oil dipstick. Do not fill above the upper mark; you could damage the engine.

Recommended Engine Oil *European models*

Oil is a major contributor to your engine's performance and longevity. Always use a premium-grade detergent oil. It is highly recommended that you use genuine Honda Motor Oil, "ACEA A1/B1," "ACEA A3/B3," or "ACEA A5/B5" in your vehicle for as long as you own it.

You can select the proper SAE/ACEA viscosity oil for your vehicle according to this chart:

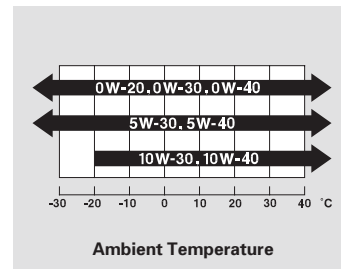

Always use genuine Honda Motor Oil or a fuel-efficient oil that says "ACEA A1/B1," "ACEA A3/B3," or "ACEA A5/B5." This oil is formulated to help your engine use less fuel.

CONTINUED





Adding Engine Oil (Petrol models)

Except for European models

Oil is a major contributor to your engine's performance and longevity. Always use a premium-grade detergent oil. It is highly recommended that you use genuine Honda Motor Oil in your vehicle for as long as you own it.

You can select the proper SAE viscosity oil for your vehicle according to this chart:

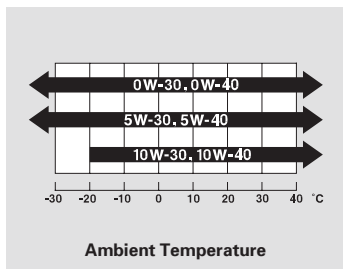

Always use a fuel-efficient oil that says "API Service SL or higher grade." This oil is formulated to help your engine use less fuel.

Engine Oil Additives

Your vehicle does not require any oil additives. Additives may adversely affect your engine's or transmission's performance and durability.





Adding Engine Oil (Diesel models)

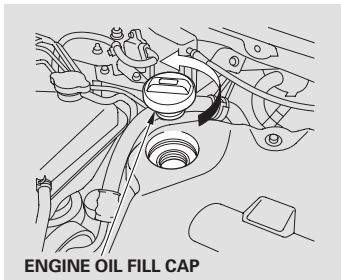

Unscrew and remove the engine oil fill cap on the valve cover. Pour in the oil slowly and carefully so you do not spill any. Clean up any spills immediately. Spilled oil could damage components in the engine compartment.

Reinstall the engine oil fill cap, and tighten it securely. Let the engine warm up and turn off the engine, let it sit for approximately 3 minutes, then check the oil level on the engine oil dipstick. Do not fill above the upper mark; you could damage the engine.

Recommended Engine Oil

Always use a synthetic motor oil that meets the ACEA specifications, and is the proper weight as shown in the following chart. When using synthetic oil, you must follow the oil and filter change intervals given in the maintenance schedule.

On Vehicles without DPF

It is highly recommended that you use genuine Honda Motor Oil or 0W-30 synthetic motor oil meeting the minimum specification: "ACEA A1/B1," "ACEA A3/B3," or "ACEA A5/B5."

You can select the proper ACEA/SAE viscosity oil for your vehicle according to this chart:

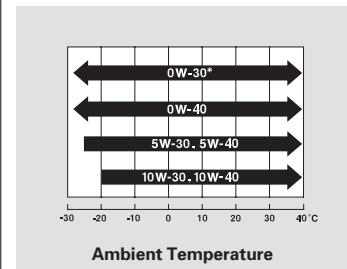

* NOTE: 0W-30 oil is formulated to improve fuel economy.

CONTINUED





Adding Engine Oil (Diesel models)

On Vehicles with DPF only

It is highly recommended that you use genuine Honda Motor Oil or 0W-30 synthetic motor oil meeting the minimum specification: "ACEA C2" or "ACEA C3."

You can select the proper ACEA/SAE viscosity oil for your vehicle according to this chart:

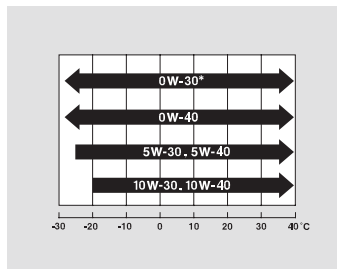

NOTE: 0W-30 oil is formulated to improve fuel economy.

Engine Oil Additives

Your vehicle does not require any oil additives. Additives may adversely affect the engine or transmission performance and durability.





Engine Coolant (Petrol models)

Adding Engine Coolant

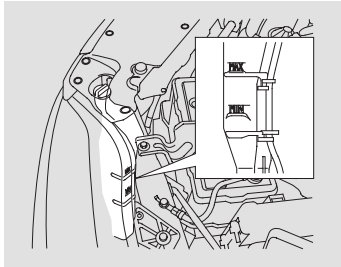

If the coolant level in the reserve tank is at or below the MIN line, add coolant to bring it up to the MAX line. Inspect the cooling system for leaks.

Always use genuine Honda All Season Antifreeze/Coolant Type 2. This coolant is pre-mixed with 50 percent antifreeze and 50 percent water. It does not require any additional mixing. Never add straight antifreeze or plain water.

The cooling system contains many aluminium components that can corrode if an improper antifreeze is used. Some antifreeze, even though labelled as safe for aluminium parts, may not provide adequate protection.

If the reserve tank is completely empty, you should also check the coolant level in the radiator.

CONTINUED

Maintenance 243





Engine Coolant (Petrol models)

⚠ WARNING

Removing the radiator cap while the engine is hot can cause the coolant to spray out, seriously scalding you.

Always let the engine and radiator cool down before removing the radiator cap.

1. Make sure the engine and radiator are cool.

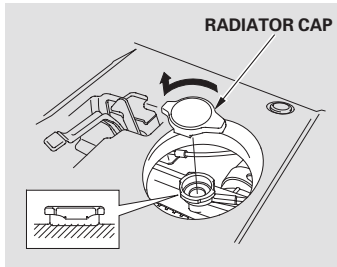

2. Relieve any pressure in the cooling system by turning the radiator cap anticlockwise, without pressing down.
3. Remove the radiator cap by pushing down and turning anticlockwise.

4. The coolant level should be up to the base of the filler neck. Add coolant if it is low.

Pour the coolant slowly and carefully so you do not spill any. Clean up any spills immediately; it could damage components in the engine compartment.

5. Put the radiator cap back on, and tighten it fully.





Engine Coolant (Petrol models)

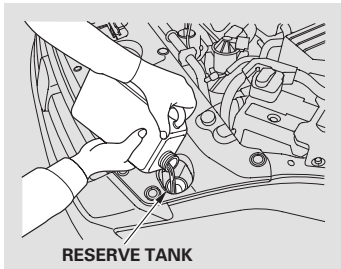

6. Remove the reserve tank cap.

7. Pour coolant into the reserve tank. Fill it to halfway between the MAX and MIN marks. Put the cap back on the reserve tank.

Do not add any rust inhibitors or other additives to your vehicle's cooling system. They may not be compatible with the coolant or engine components.





Engine Coolant (Diesel models)

Adding Engine Coolant

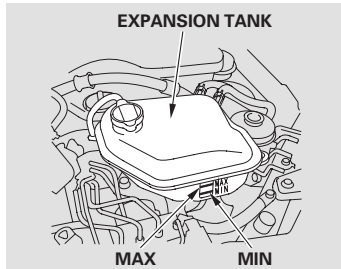

If the coolant level in the expansion tank is at or below the MIN line, add coolant to bring it up to the MAX line. Inspect the cooling system for leaks.

Always use genuine Honda All Season Antifreeze/Coolant Type 2. This coolant is pre-mixed with 50 percent antifreeze and 50 percent water. Never add straight antifreeze or plain water.

The cooling system contains many aluminium components that can corrode if an improper antifreeze is used. Some antifreeze, even though labelled as safe for aluminium parts, may not provide adequate protection.

⚠ WARNING

Removing the expansion tank cap while the engine is hot can cause the coolant to spray out, seriously scalding you.

Always let the engine and radiator cool down before removing the expansion tank cap.





Engine Coolant (Diesel models)

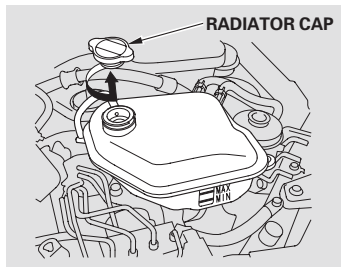

1. Make sure the engine and radiator are cool.
2. Loosen the expansion tank cap by turning it 1/8 turn anticlockwise. This will relieve any remaining pressure in the cooling system.
3. Remove the expansion tank cap by pushing down and turning anticlockwise.

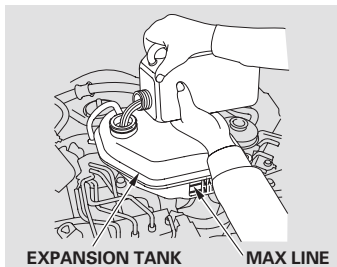

4. The coolant level should be up to the MAX line. Add coolant if it is low.

Pour the coolant slowly and carefully so you do not spill any. Clean up any spills immediately; it could damage components in the engine compartment.

5. Put the expansion tank cap back on, and tighten it fully.

Do not add any rust inhibitors or other additives to your vehicle's cooling system. They may not be compatible with the coolant or engine components.





Windscreen Washers

Check the fluid level in the windscreen washer reservoir at least monthly during normal use.

Check the reservoir's fluid level by removing the cap and looking at the level gauge attached to the cap.

Fill the reservoir with a good-quality windscreen washer fluid. This increases the cleaning capability and prevents freezing in cold weather.

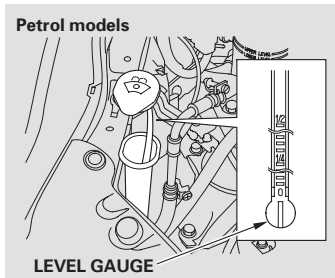

When you refill the reservoir, clean the edges of the windscreen wiper blades with windscreen washer fluid on a clean cloth. This will help to condition the blade edges.

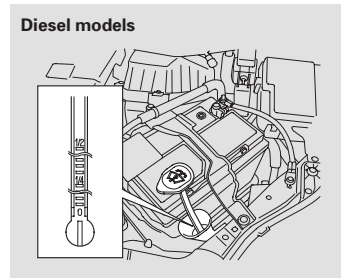

NOTICE

Do not use engine antifreeze or a vinegar/water solution in the windscreen washer reservoir. Antifreeze can damage your vehicle's paint, while a vinegar/water solution can damage the windscreen washer pump. Use only commercially-available windscreen washer fluid.





Transmission Fluid

Manual Transmission Fluid

The transmission should be drained and refilled with new fluid according to the time and distance recommendations in the maintenance schedule.

Always use genuine Honda Manual Transmission Fluid (MTF). If it is not available, you may use an API service SE or higher grade motor oil with a viscosity of SAE 0W-20 or 5W-20 as a temporary replacement. However, motor oil does not contain the proper additives, and continued use can cause stiffer shifting. Replace as soon as it is convenient.

Automatic Transmission Fluid

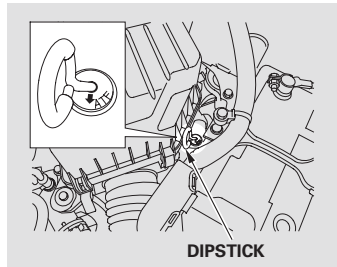

Check the fluid level with the engine and transmission at normal operating temperature.

1. Park the vehicle on level ground. Start the engine and let it run until the radiator fan comes on, then shut off the engine. For accurate results, wait about 60 seconds before going to step 2, but don't wait longer than 90 seconds.

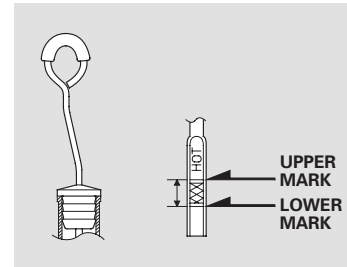

2. Remove the dipstick (yellow loop) from the transmission, and wipe it with a clean cloth.
3. Insert the dipstick all the way back into the transmission securely as shown in the illustration.

CONTINUED

Maintenance 249





Transmission Fluid, Brake and Clutch Fluid

4. Remove the dipstick and check the fluid level. It should be between the upper and lower marks.
5. If the level is below the lower mark, add fluid into the dipstick hole to bring it to the level between the upper and lower marks.

Pour the fluid slowly and carefully so you do not spill any. Clean up any spills immediately; it could damage components in the engine compartment.

Always use genuine Honda ATF-Z1 (Automatic Transmission Fluid). If it is not available, you may use a DEXRON® III automatic transmission fluid as a temporary replacement. However, continued use can affect the shift quality. Have the transmission flushed and refilled with genuine Honda ATF-Z1 by your dealer as soon as it is convenient.

6. Insert the dipstick all the way back into the transmission securely as shown in the illustration.

If you are not sure how to add fluid, contact your dealer.

Brake and Clutch Fluid

Check the fluid level in the reservoirs monthly.

- Brake fluid reservoir
 - Clutch fluid reservoir
- (Manual transmission only)

Replace the brake fluid according to the time recommendation in the maintenance schedule.

Always use genuine Honda Brake Fluid or an equivalent from a sealed container that is marked DOT3 or DOT4 only. Brake fluid marked DOT5 is not compatible with your vehicle's braking system.





Brake and Clutch Fluid

Brake System

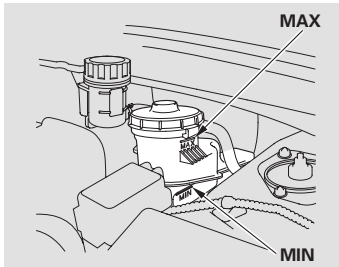

The fluid level should be between the MIN and MAX marks on the side of the reservoir. If the level is at or below the MIN mark, your brake system needs attention. Have the brake system inspected for leaks or worn brake pads.

Clutch System

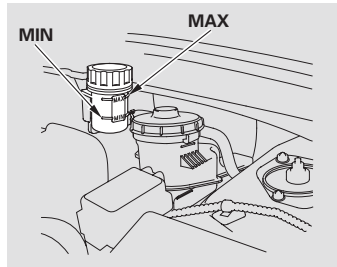

The fluid level should be between the MIN and MAX marks on the side of the reservoir. If it is not, add brake fluid to bring it up to that level. Use the same fluid specified for the brake system.

A low fluid level can indicate a leak in the clutch system. Have this system inspected as soon as possible.





Power Steering Fluid

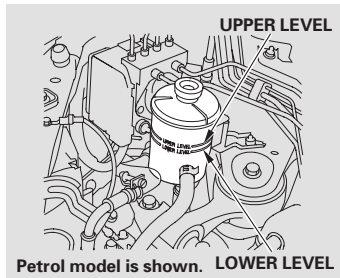

You should check the fluid level in the power steering reservoir at least once a year. Check the level on the side of the reservoir when the engine is cold. The fluid should be between the UPPER LEVEL and LOWER LEVEL. If not, add power steering fluid to the UPPER LEVEL mark.

Pour the fluid slowly and carefully so you do not spill any. Clean up any spills immediately; it could damage components in the engine compartment.

NOTICE

Using automatic transmission fluid or another brand of power steering fluid will damage the system. Use only genuine Honda Power Steering Fluid (V, II or S).

A low power steering fluid level can indicate a leak in the system. Check the fluid level frequently, and have the system inspected as soon as possible.

NOTICE

Turning the steering wheel to full left or right lock and holding it there can damage the power steering pump.





Air Cleaner Element

The air cleaner element should be cleaned or replaced according to the time and distance recommendations in the maintenance schedule.

Cleaning

On vehicles with dry type air cleaner element

The air cleaner element is inside the air cleaner housing in the engine compartment.

Clean the air cleaner element by blowing compressed air through it in the opposite direction to normal air flow. If you do not have access to compressed air (such as a service station), ask your dealer to do this service.

Follow the replacement procedure for removal and reinstallation.

Replacement

Petrol models

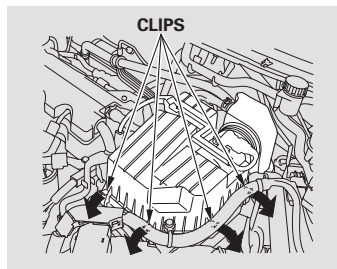

To replace it:

1. Unsnap the four hold-down clips and remove the air cleaner housing cover.
2. Remove the old air cleaner element.

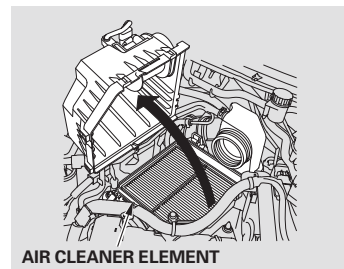

3. Carefully clean the inside of the air cleaner housing with a damp rag.
4. Place the new air cleaner element in the air cleaner housing.
5. Reinstall the air cleaner housing cover, and snap the four hold-down clips back into place.

CONTINUED





Air Cleaner Element

Diesel models

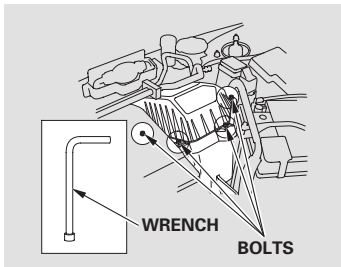

1. Loosen the four bolts with the wrench included in the tool kit (see page 298).

Make sure to locate the air cleaner housing bolts as shown. Do not loosen the socket bolt holding the air flow meter.

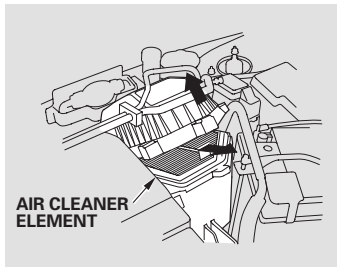

2. Pull up the front of the air cleaner housing cover, and then remove the old air cleaner element.
3. Carefully clean the inside of the air cleaner housing with a damp rag.

4. Place the new air cleaner element in the air cleaner housing.
5. Pull down the front of the air cleaner housing cover and tighten the four bolts securely.





Fuel Filter

The fuel filter should be replaced according to the time and distance recommendations in the maintenance schedule.

Have a qualified technician change the fuel filter. Since the fuel system is under pressure, fuel can spray out and create a hazard if all fuel line connections are not handled correctly.

Except EU (Petrol models only)
It is recommended to replace the fuel filter every 40,000 km (25,000 miles), or 2 years, if the fuel you are using is suspected to be contaminated. In a high dust environment, the filter may become clogged sooner.

Draining Water (Diesel models only)

When water stays in the fuel system, the Water In Diesel Filter indicator comes on and stays on while the engine is running. Contact your dealer as soon as possible (see page 284).

On European models

The fuel filter should be drained of water according to the time and distance recommendations in the maintenance schedule.

After the vehicle has been stored for an extended period, the engine may not start. This may be caused by air in the fuel system. In this case, follow the procedure for **Priming the Fuel System** (see page 284).





Lights

Check the operation of your vehicle's exterior lights at least once a month. A burned out bulb can make the condition of your vehicle unsafe reducing your vehicle's visibility and the ability to signal your intentions to other drivers.

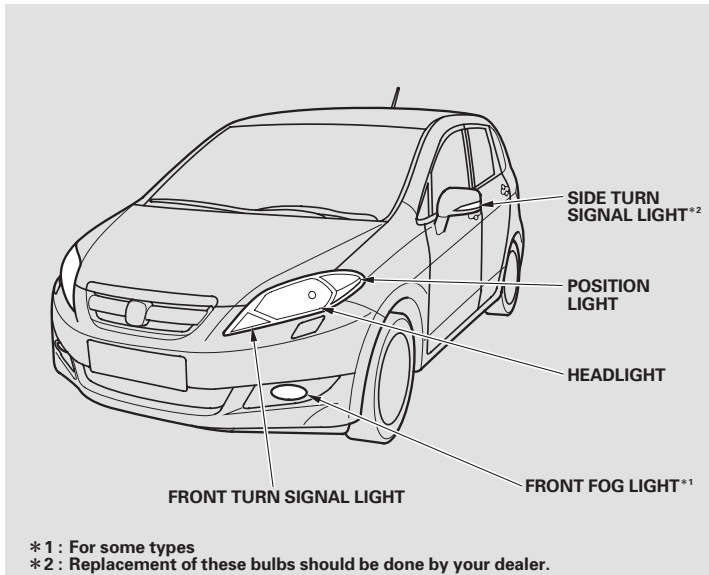



Lights

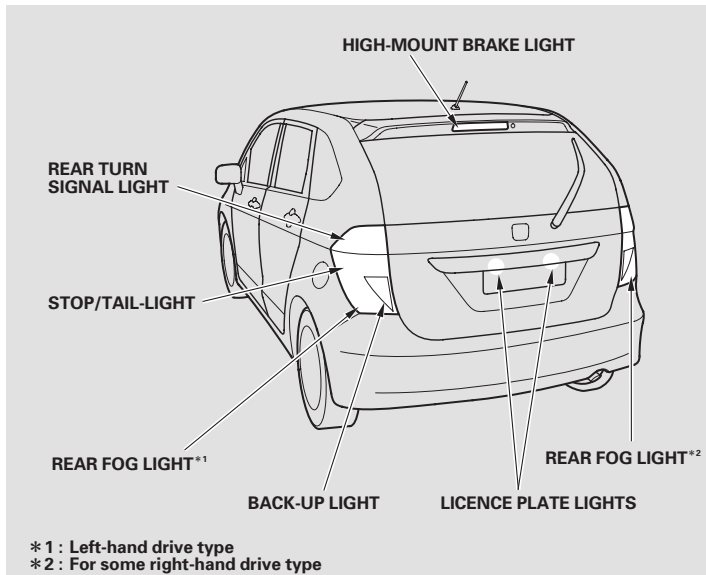

Check the following:

- Headlights (low and high beam)
- Position lights
- Tail-lights
- Brake lights
- Turn signals
- Side turn signals
- Back-up lights
- Hazard light function
- Licence plate lights
- High-mount brake light
- Rear fog light (for some types)
- Front fog lights (for some types)

If you find any bulbs are burned out, replace them as soon as possible. Refer to the chart on page 335 to determine what type of replacement bulb is needed.





Lights

Headlight Aiming

The headlights were properly aimed when your vehicle was new. If you regularly carry heavy items in the luggage area or pull a trailer (if applicable), readjustment may be required. Adjustment should be done by your dealer or other qualified technician.

On vehicles with headlight adjuster
The vertical angle of the headlights can be adjusted. For more information, see page 122 .

On vehicles with high voltage discharge type headlights
Your vehicle is equipped with an automatic headlight adjusting system that adjusts the vertical angle of the headlights automatically. Refer to page 122 for more information.

Headlights with High Voltage Discharge Tubes (For some types)

The headlight bulbs are a type of high voltage discharge tube. High voltage can remain in the circuit even with the light switch off and the key removed. Because of this, you should not attempt to examine or change a headlight bulb yourself. If a headlight bulb fails, take your vehicle to a dealer to have it replaced.

Replacing a Headlight Bulb

Your vehicle has halogen headlight bulbs (for some types), one on each side. When replacing a bulb, handle it by its steel base and protect the glass from contact with your skin or hard objects. If you touch the glass, clean it with denatured alcohol and a clean cloth.

NOTICE

Halogen headlight bulbs get very hot when lit. Oil, perspiration, or a scratch on the glass can cause the bulb to overheat and shatter.





Lights

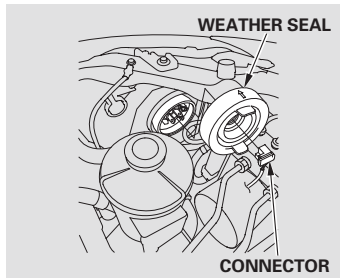

1. Open the bonnet.
2. Remove the electrical connector from the bulb by pulling the connector straight off.

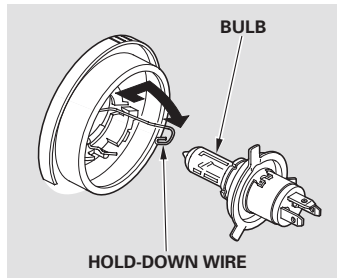

3. Remove the rubber weather seal by pulling it.
4. Unclip the end of the hold-down wire from its slot. Pivot it out of the way, and remove the bulb.

5. Insert the new bulb into the hole, making sure the tabs are in their slots. Pivot the hold-down wire back in place, and clip the end into the slot.
6. Install the rubber weather seal over the back of the headlight assembly. Make sure it is right side up.
7. Push the electrical connector onto the tabs of the new bulb. Make sure it locks in place. Turn on the headlights to test the new bulb.





Lights

Replacing a Front Turn Signal Light Bulb

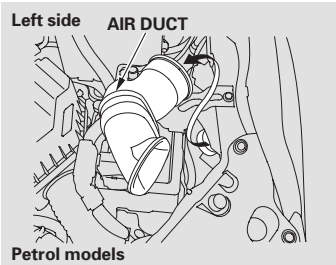

1. Open the bonnet.

(Left side)

Petrol models

Remove the air duct by pulling it straight out.

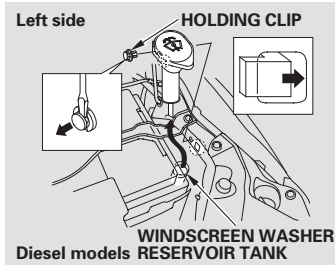

Diesel models

Remove the upper part of the windscreen washer reservoir tank.

Use a flat-tipped screwdriver to remove the holding clip, then remove the upper part.

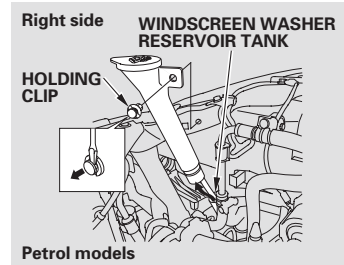

(Right side)

Petrol models

Remove the upper part of the windscreen washer reservoir tank.

Use a flat-tipped screwdriver to remove the holding clip, then remove the upper part.





Lights

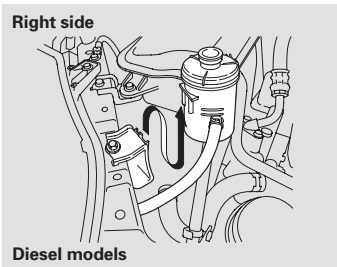

Diesel models
Remove the power steering fluid tank.

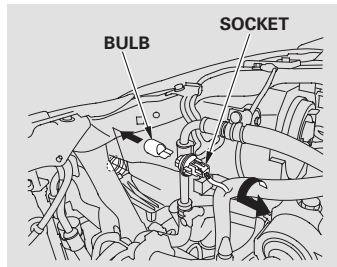

2. Remove the socket from the headlight assembly by turning it one-quarter turn anticlockwise.
3. Pull the bulb straight out of its socket. Push the new bulb straight into the socket until it bottoms.
4. Insert the socket back into the headlight assembly. Turn it clockwise to lock it in place.

5. Test the lights to make sure the new bulb is working.

6. (Left side)
Petrol models
Install the air duct into its hole.

Diesel models
Install the upper part of the windscreen washer reservoir tank in the reverse order of removal.

(Right side)
Petrol models
Install the upper part of the windscreen washer reservoir tank in the reverse order of removal.

Diesel models
Install the power steering fluid tank.





Lights

Replacing a Front Position Light Bulb

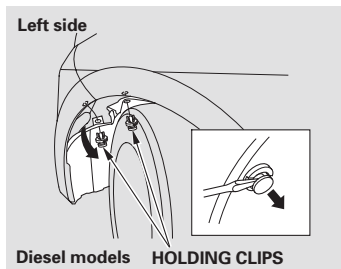

On diesel models

1. If you are changing the bulb on the left side, start the engine, turn the steering wheel all the way to the right, and turn off the engine. If you are changing the bulb on the right side, turn the steering wheel to the left.

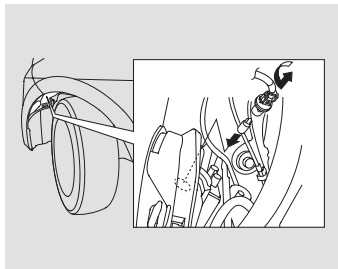

2. Use a flat-tipped screwdriver to remove the two holding clips from the inner fender.
3. Pull the inner fender cover back.
4. Remove the socket from the headlight assembly by turning it one-quarter turn anticlockwise.

5. Pull the bulb straight out of its socket. Push the new bulb straight into the socket until it bottoms.

6. Insert the socket back into the headlight assembly. Turn it clockwise to lock it in place.

7. Turn on the position lights to make sure the new bulb works.

8. Put the inner fender cover back into its place. Install the holding clips. Lock each clip by pushing in the centre.





Lights

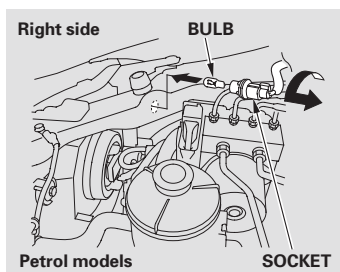

On petrol models

1. Open the bonnet.
2. Remove the socket from the headlight assembly by turning it one-quarter turn anticlockwise.

3. Pull the bulb straight out of its socket. Push the new bulb straight into the socket until it bottoms.
4. Insert the socket back into the headlight assembly. Turn it clockwise to lock it in place.
5. Turn on the position lights to make sure the new bulb works.

Replacing Rear Bulbs

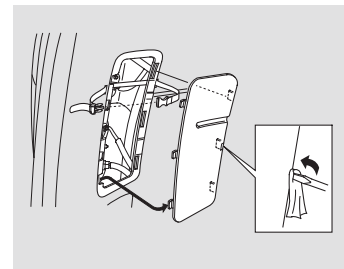

1. To access the bulbs, remove the cover for the side of the blown bulb. Open the tailgate. Disconnect the band connector of the cover. Remove the cover by carefully prying on its edge with a small flat-tipped screwdriver.

CONTINUED





Lights

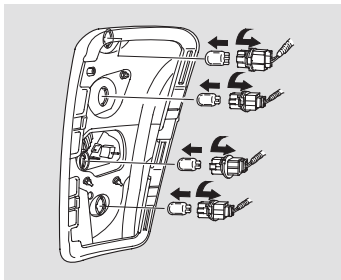

2. Determine which of the four bulbs is burned out: stop/tail-light, back-up light, turn signal light or rear fog light.
3. Remove the socket by turning it one-quarter turn anticlockwise.

4. Pull the bulb straight out of its socket.
5. Install the new bulb in the socket.
6. Test the lights to make sure the new bulb is working. Reinstall the socket by turning it clockwise until it locks.
7. Reinstall the cover. Connect the band connector.

Replacing a High-mount Brake Light Bulb

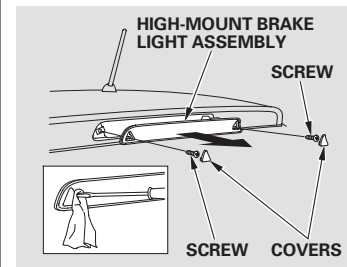

1. Place a cloth on the edge of the cover. Remove the covers by carefully prying on the edge with a small flat-tipped screwdriver.

Use a Phillips-head screwdriver to remove the two screws, then remove the high-mount brake light assembly.





Lights

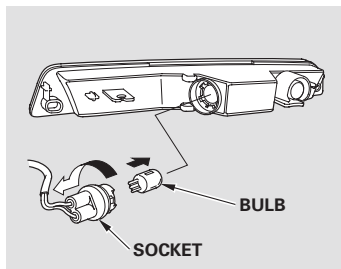

2. Remove the socket from the light assembly by turning it one-quarter turn anticlockwise.
3. Pull the bulb straight out of its socket. Push the new bulb straight into the socket until it bottoms.

4. Test the lights to make sure the new bulb is working.
5. Put the socket back into the light assembly, and turn it clockwise to lock it in place.
6. Reinstall the high-mount brake light assembly into the tailgate. Tighten the two screws and reinstall the covers.

Replacing a Rear Licence Plate Bulb

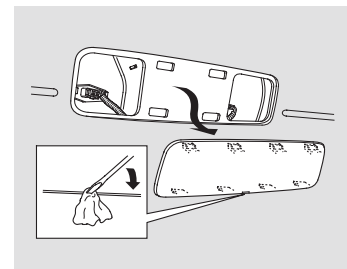

1. Open the tailgate. Place a cloth on the edge of the cover. Remove it by carefully prying in the notch on its middle edge with a small flat-tipped screwdriver.

CONTINUED





Lights

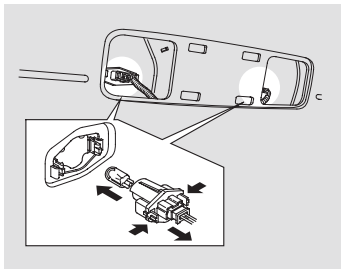

2. Remove the license light assembly by squeezing the tabs on both sides of the socket.
3. Pull the bulb straight out of its socket. Push the new bulb in until it bottoms in the socket.

4. Turn on the position lights and check that the new bulb is working.
5. Reinstall the socket. Snap the cover back in place.

Replacing a Front Fog Light Bulb (For some types)

Your vehicle uses halogen light bulbs. When replacing a bulb, handle it by its plastic case, and protect the glass from contact with your skin or hard objects. If you touch the glass, clean it with denatured alcohol and a clean cloth.

NOTICE

Halogen light bulbs get very hot when lit. Oil, perspiration, or a scratch on the glass can cause the bulb to overheat and shatter.

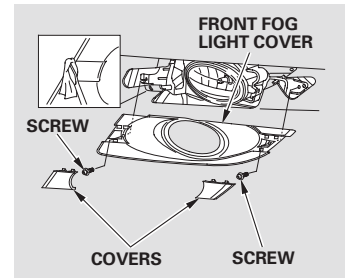

1. Place a cloth on the edge of each cover. Remove the covers by carefully prying in the notch on its edge with a small flat-tipped screwdriver.
2. Use a Phillips-head screwdriver to remove the screws.
3. Remove the front fog light cover.





Lights

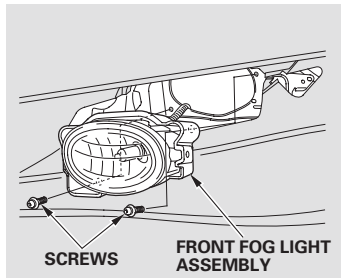

4. Remove the front fog light assembly by removing the screws.

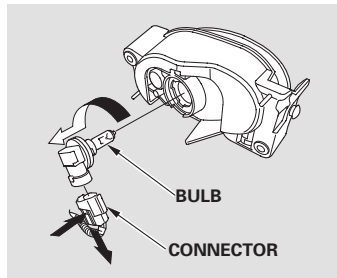

5. Remove the electrical connector from the bulb by squeezing the connector to unlock the tab, then slide the connector off the bulb.

6. Remove the bulb by turning it approximately one-quarter turn anticlockwise.

7. Insert the new bulb into the hole, and turn it one-quarter turn clockwise to lock it in place.

8. Push the electrical connector back onto the bulb. Make sure it is on all the way.

9. Turn on the front fog lights to test the new bulb.

10. Reinstall the front fog light assembly back in place, then tighten the screws.

11. Reinstall the front fog light cover, then tighten the screws and reinstall the covers.





Lights

Replacing Bulbs in the Interior Lights

The ceiling lights and spotlights come apart the same way.

1. Remove the lens by carefully prying on the edge of it with a fingernail file or a small flat-tip screwdriver. Do not pry on the edge of the housing around the lens.

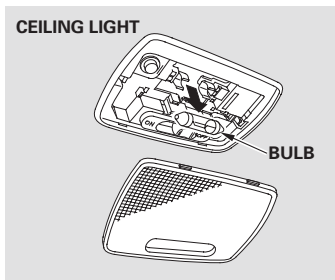

Ceiling light:
Pry on the front edge of the lens near both sides.

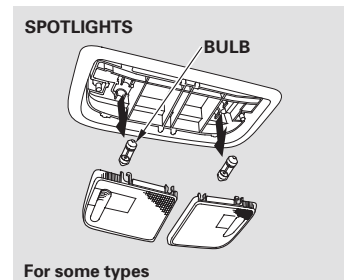

For some types

- Spotlights:
1. Pry on the inner edge of both spotlights.
 2. Remove the bulb by pulling it straight out of its metal tabs.





Lights

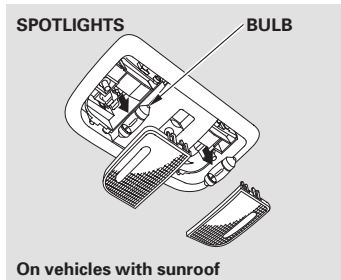

3. Push the new bulb into the metal tabs. Carefully snap the lens back in place.

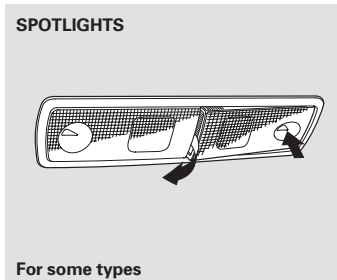

1. Check which bulb is burned out. Push on the lens of the opposite side you are replacing.
2. Remove the lens of the burned out bulb by carefully prying on the edge between the lenses with a fingernail file or a small flat-tip screwdriver.

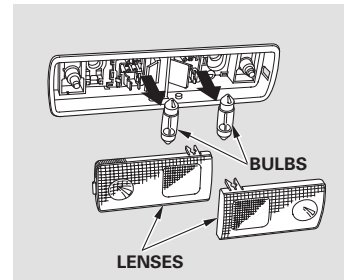

3. Remove the bulb by pulling it straight out of the bulb holder.
4. Push the new bulb into the bulb holder.
5. Reinstall the lens in place.





Air Conditioning System

Your vehicle's air conditioning is a sealed system. Any major maintenance, such as recharging, should be done by a qualified technician. You can do a couple of things to make sure the air conditioning works efficiently.

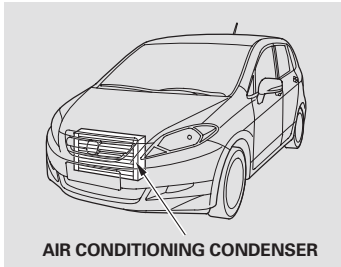

Periodically check the engine's radiator and air conditioning condenser for leaves, insects, and dirt stuck to the front surface. These block the air flow and reduce cooling efficiency. Use a light spray from a hose or a soft brush to remove them.

NOTICE

The condenser and radiator fins bend easily. Only use a low-pressure spray or soft-bristle brush to clean them.

Run the air conditioning at least once a week during the cold weather months. Run it for at least 10 minutes while you are driving at a steady speed with the engine at normal operating temperature. This circulates the lubricating oil contained in the refrigerant.

If the air conditioning does not get as cold as before, have your dealer check the system. Recharge the system with Refrigerant HFC-134a (R-134a).

NOTICE

Whenever you have the air conditioning system serviced, make sure the service facility uses a refrigerant recycling system. This system captures the refrigerant for reuse. Releasing refrigerant into the atmosphere can damage the environment.





Wiper Blades

Check the condition of the wiper blades at least every 6 months. Replace them if you find signs of cracking in the rubber, and areas that are getting hard or if they leave streaks and unwiped areas when used.

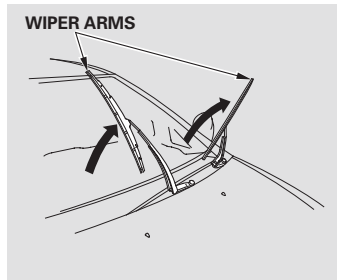

To replace a front wiper blade:

1. Raise the wiper arm off the windshield. Raise the driver's side first, then the passenger's side.

NOTICE

Do not open the bonnet when the wiper arms are raised, or you will damage the bonnet and the wiper arms.

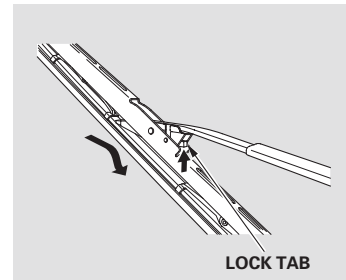

2. Disconnect the blade assembly from the wiper arm by pushing in the lock tab. Hold the lock tab in while you push the blade assembly toward the base of the arm.

CONTINUED





Wiper Blades

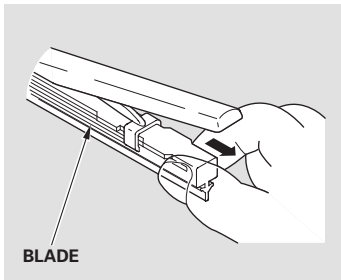

3. Remove the blade from its holder by grasping the tabbed end of the blade. Pull firmly until the tabs come out of the holder.

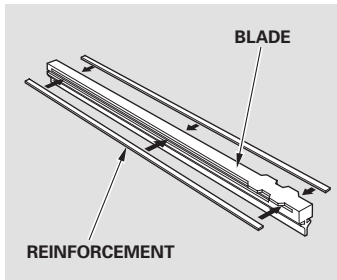

4. Examine the new wiper blades. If they have no plastic or metal reinforcement along the back edge, remove the metal reinforcement strips from the old wiper blade, and install them in the slots along the edge of the new blade.

5. Slide the new wiper blade into the holder until the tabs lock.

6. Slide the wiper blade assembly onto the wiper arm. Make sure it locks in place.

7. Lower the wiper arm down against the windscreen, the passenger's side first, then the driver's side.





Wiper Blades

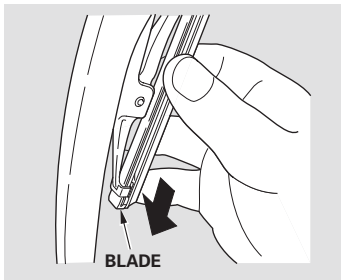

To replace a rear wiper blade:

1. Raise the wiper arm off the windscreen.
2. Remove the blade from its holder by grasping the tabbed end of the blade. Pull firmly until the tabs come out of the holder.

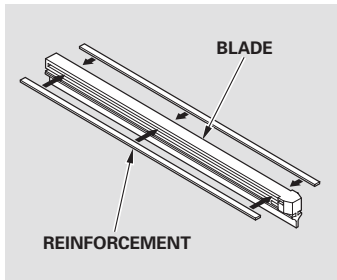

3. Examine the new wiper blades. If they have no plastic or metal reinforcement along the back edge, remove the metal reinforcement strips from the old wiper blade, and install them in the slots along the edge of the new blade.

4. Slide the new wiper blade into the holder until the tabs lock.
5. Slide the wiper blade assembly onto the wiper arm. Make sure it locks in place.
6. Lower the wiper arm.





Tyres

To safely operate your vehicle, your tyres must be the proper type and size, in good condition with adequate tread, and correctly inflated.

The following pages give more detailed information on how to take care of your tyres and what to do when they need to be replaced.

⚠ WARNING

Using tyres that are excessively worn or improperly inflated can cause a crash in which you can be seriously hurt or killed.

Follow all instructions in this owner's manual regarding tyre inflation and maintenance.

Inflation Guidelines

Keeping the tyres properly inflated provides the best combination of handling, tread life, and riding comfort.

- Underinflated tyres wear unevenly, adversely affect handling and fuel economy, and are more likely to fail from being overheated.
- Overinflated tyres can make your vehicle ride more harshly, are more prone to damage from road hazards, and wear unevenly.

We recommend that you visually check your tyres every day. If you think a tyre might be low, check it immediately with a tyre gauge.

Use a gauge to measure the air pressure in each tyre at least once a month. Even tyres that are in good condition may lose 10 to 20 kPa (0.1 to 0.2 kgf/cm², 1 to 2 psi) per month. Remember to check the spare tyre at the same time.

Check the air pressures when the tyres are cold. This means the vehicle has been parked for at least 3 hours, or driven less than 1.6 km (1 mile).

Add or release air, if needed, to match the recommended cold tyre pressures on a label on the driver's doorjamb.





Tyres

If you check air pressures when the tyres are hot [driven for several kilometers (miles)], you will see readings 30 to 40 kPa (0.3 to 0.4 kgf/cm², 4 to 6 psi) higher than the cold reading. This is normal. Do not let air out to match the recommended cold air pressure. The tyre will be underinflated.

While tubeless tyres have some ability to self-seal if they are punctured, you should look closely for punctures if a tyre starts losing pressure.

You should use your own tyre pressure gauge whenever you check your tyre pressures. This will make it easier for you to tell if a pressure loss is due to a tyre problem and not due to a variation between gauges.

For convenience, the recommended tyre sizes and cold tyre pressures are on a label on the driver's doorjamb.

Tyre Inspection

Every time you check inflation, you should also examine the tyres for damage, foreign objects, and wear. You should look for:

- Bumps or bulges in the tread or side of the tyre. Replace the tyre if you find either of these conditions.
- Cuts, splits, or cracks in the side of the tyre. Replace the tyre if you can see fabric or cord.
- Excessive tread wear.

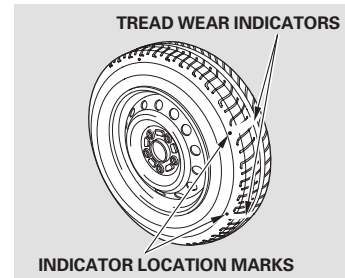

Your tyres have wear indicators moulded into the tread. When the tread wears down, you will see a 12.7 mm (1/2 inch) wide band across the tread. This shows there is less than 1.6 mm (1/16 inch) of tread left on the tyre.

A tyre this worn gives very little traction on wet roads. You should replace the tyre if you can see three or more tread wear indicators.





Tyres

Tyre Maintenance

In addition to proper inflation, correct wheel alignment helps to decrease tyre wear. If you find a tyre is worn unevenly, have your dealer check the wheel alignment.

Have your dealer check the tyres if you feel a consistent vibration while driving. A tyre should always be rebalanced if it is removed from the wheel. When you have new tyres installed, make sure they are balanced. This increases riding comfort and tyre life. For best results, have the installer perform a dynamic balance.

NOTICE

For vehicles equipped with aluminium wheels:
Improper wheel weights can damage your vehicle's aluminium wheels. Use only genuine Honda wheel weights for balancing.

Tyre Rotation

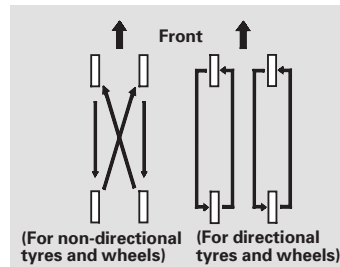

To help increase tyre life and distribute wear more evenly, rotate the tyres every 10,000 km (6,250 miles). Move the tyres to the positions shown in the chart each time they are rotated. The above illustration shows how the tyres should be rotated on the vehicles equipped with a compact spare tyre.

If you purchase directional tyres, rotate only front-to-back.

When the tyres are rotated, make sure the air pressures are checked.





Tyres

Replacing Tyres and Wheels

Replace your tyres with radial tyres of the same size, load range, speed rating, and maximum cold tyre pressure rating (as shown on the tyre's sidewall).

Mixing radial and bias-ply tyres on your vehicle can reduce braking ability, traction, and steering accuracy. Using tyres of a different size or construction can cause the ABS and vehicle stability assist system (VSA) to work inconsistently.

The ABS and VSA work by comparing the speed of the wheels. When replacing tyres, use the same size originally supplied with the vehicle. Tyre size and construction can affect wheel speed and may cause the system to work inconsistently.

It is best to replace all four tyres at the same time. If that is not possible or necessary, replace the two front tyres or two rear tyres as a pair. Replacing just one tyre can seriously affect your vehicle's handling.

If you ever replace a wheel, make sure that the wheel's specifications match those of the original wheels. Consult your dealer before replacing tyres.

⚠ WARNING

Installing improper tyres on your vehicle can affect handling and stability. This can cause a crash in which you can be seriously hurt or killed.

Always use the size and type of tyres recommended in the tyre information label on your vehicle.





Tyres

Wheels and Tyres

Wheels:
16 x 6 1/2 JJ

Tyres:
205/55R16 91V

See the tyre information label on the driver's doorjamb or ask your dealer for information on the proper size of the tyres on your vehicle.

Replacement wheels are available at your dealer.

Winter Tyres

Because of the limited winter qualification of summer tyres for winter use we recommend the use of winter tyres (M+S tyres) on snowy and icy roads. If M+S tyres are installed, all four wheels should be equipped to insure safe driving. Use only tyres of the same brand with the same profile. Pay attention to the tyre size, load capacity and speed class when buying.

Install the winter tyres according to the remarks in the registration paper. According to the EEC Directive for tyres, when winter tyres are used, it is necessary to affix a sticker with the allowable max. speed of the winter tyres clearly in the field of view of the driver, if the designed max. speed of vehicle is higher than the allowed max. speed of winter tyre. A sticker is obtainable from your tyre dealer. If any questions arise, please discuss these with one of our dealers.





Tyres

Tyre Chains

Use snow chains only in an emergency or when they are legally required for driving through a certain area. Install the snow chains on the front wheels. Use greater caution when driving with snow chains on snow or ice. They may have less-predictable handling than good winter tyres without chains. Some snow chains may damage the vehicle's tyres, wheels, suspension and body. Choose only fine limbed chains which guarantee enough free space between the tyre and the other vehicle parts in the wheelhouse. Pay attention to the sectional assembly view and other directions from the chain manufacturer. Consult your dealer before purchasing any type of chains for your vehicle.

When you have installed tyre chains, drive at less than 30 km/h (19 mph) on roads covered with snow or ice. To minimize tyre and chain wear, avoid driving on cleared roads with chains installed.





Tyres

(EU models)

Use only the specified chains or their equivalents for your tyres as listed.

Original Tyre Size	Chain Type
205/55R16	Rud-matic classic 48482 or equivalents



280 Maintenance





Checking the Battery

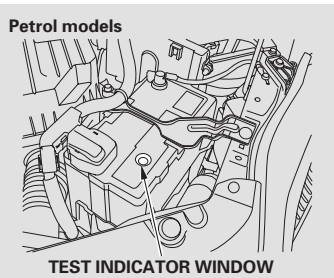

Check the condition of the battery monthly by looking at the test indicator window. The label on the battery explains the test indicator's colours.

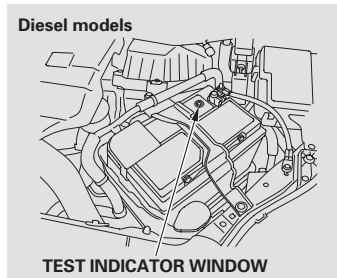

Check the terminals for corrosion (a white or yellowish powder). To remove it, cover the terminals with a solution of baking soda and water. It will bubble up and turn brown. When this stops, wash it off with plain water. Dry off the battery with a cloth or paper towel. Coat the terminals with grease to help prevent future corrosion.

If additional battery maintenance is needed, see your dealer or a qualified technician.

If you need to connect the battery to a charger, disconnect both cables to prevent damaging your vehicle's electrical system. Always disconnect the negative (-) cable first, and reconnect it last.

CONTINUED

Maintenance 281





Checking the Battery

⚠ WARNING

The battery gives off explosive hydrogen gas during normal operation. A spark or open flame can cause the battery to explode with enough force to kill or seriously hurt you.

Keep all sparks, open flames, and smoking materials away from the battery.

Wear protective clothing and a face shield, or have a skilled technician do the battery maintenance.

⚠ WARNING

The battery contains sulfuric acid (electrolyte) which is highly corrosive and poisonous.

Getting electrolyte in your eyes or on your skin can cause serious burns. Wear protective clothing and eye protection when working on or near the battery.

Swallowing electrolyte can cause fatal poisoning if immediate action is not taken.

KEEP OUT OF THE REACH OF CHILDREN

Emergency Procedures

Eyes — Flush with water from a cup or other container for at least 15 minutes. (Water under pressure can damage the eye.) Call a physician immediately.

Skin — Remove contaminated clothing. Flush the skin with large quantities of water. Call a physician immediately.

Swallowing — Drink water or milk. Call a physician immediately.





Vehicle Storage

If you need to park your vehicle for an extended period (more than 1 month), there are several things you should do to prepare it for storage. Proper preparation helps prevent deterioration and makes it easier to get your vehicle back on the road. If possible, store your vehicle indoors.

- Fill the fuel tank.
- Change the engine oil and filter.
- Wash and dry the exterior completely.
- Clean the interior. Make sure the carpeting, floor mats, etc., are completely dry.
- Leave the parking brake off. Put the transmission in reverse (manual) or Park (automatic).

- Block the rear wheels.
- If the vehicle is to be stored for a longer period, it should be supported on jackstands so the tyres are off the ground.
- Leave one window open slightly (if the vehicle is being stored indoors).
- Disconnect the battery.
- Support the front and rear wiper blade arms with a folded towel or rag so they do not touch the windscreen.
- To minimize sticking, apply a silicone spray lubricant to all door and tailgate seals. Also, apply a vehicle body wax to the painted surfaces that mate with the door and tailgate seals.

- Cover the vehicle with a “breathable” cover, one made from a porous material such as cotton. Non-porous materials, such as plastic sheeting, trap moisture, which can damage the paint.

- If possible, periodically run the engine until it reaches full operating temperature (the cooling fans cycle on and off twice). Preferably, do this once a month.

On diesel models only

- After you parked the vehicle for an extended period, water stays in the fuel system and the engine will not start. In this case, the fuel filter may be needed to drain off water (see **Draining Water** on page 255).

CONTINUED





Vehicle Storage

If you store your vehicle for 1 year or longer, have your dealer perform the maintenance inspections called for in the 2 years/40,000 km (25,000 miles) maintenance schedule* as soon as you take it out of storage (see page 229). The replacements called for in the maintenance schedule are not needed unless the vehicle has actually reached that time or distance.

* : For EU countries, see the Service Book.

Priming the Fuel System (Diesel models only)

If your vehicle runs out of fuel, the malfunction indicator lamp will come on, or the glow plugs indicator will blink, and the engine will not restart after refueling the fuel tank with the appropriate fuel (see pages 315 and 316).

In this case, air may have entered the fuel system. The system requires priming to start the engine. Prime the fuel system as follows:

1. Refuel the fuel tank (minimum 5 litres).
2. Open the bonnet.

FUEL HAND PRIMER

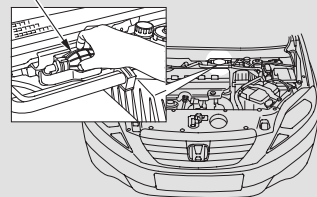

3. Squeeze the fuel hand primer until you feel the strong resistance.

NOTICE

Do not press the engine cover forcibly. This may damage the engine cover and component parts.





Vehicle Storage

4. Start the engine (see page 203). If the engine does not start right away, do not hold the ignition switch for more than 10 seconds at a time. This will damage the fuel pump and the engine starter.

5. If the engine fails to start, return to step 3.

6. After the engine restarts, press the accelerator pedal slightly and hold it at approximately 1,500 rpm for about 30 seconds. This will complete the air bleeding in the fuel system.

7. The engine runs normally, but the malfunction indicator lamp or the glow plugs indicator remains lit.

To turn off the indicator, restart and turn off the engine at least three times at intervals of approximately 30 seconds.

If this procedure is performed during normal driving, the indicator will be turned off.

If you are not sure how to bleed the air, contact your dealer.

If the engine fails to restart after priming the fuel system, there is a problem in the fuel system. You should have the vehicle inspected by your dealer.





06/10/30 17:21:03 32SJD620_289





Appearance Care

Regular cleaning and polishing of your vehicle helps to keep it “new” looking. This section gives you information on how to clean your vehicle and preserve its appearance: the paint, brightwork, wheels and interior. Also included are several things you can do to help prevent corrosion.

Exterior Care.....	288
Washing	288
Roof Antenna	289
Waxing.....	289
Aluminium Wheels.....	290
Paint Touch-up.....	290
Interior Care.....	291
Carpeting	291
Floor Mats	291
Fabric	291
Vinyl	291
Leather.....	292
Windows	292
Seat Belts.....	292
Air Fresheners.....	293
Dust and Pollen Filter	293
Corrosion Protection.....	294





Exterior Care

Washing

Frequent washing helps preserve your vehicle's beauty. Dirt and grit can scratch the paint, while tree sap and bird droppings can permanently ruin the finish.

Wash your vehicle in a shady area, not in direct sunlight. If the vehicle is parked in the sun, move it into the shade and let the exterior cool down before you start.

Only use the solvents and cleaners recommended in this owner's manual.

NOTICE

Chemical solvents and strong cleaners can damage the paint, metal, and plastic on your vehicle.

- Rinse the vehicle thoroughly with cool water to remove loose dirt.
- Fill a bucket with cool water. Mix in a product made especially for car washing.
- Wash the vehicle using water and detergent solution and a soft-bristle brush, sponge, or soft cloth. Start at the top and work your way down. Rinse frequently.
- Check the body for road tar, tree sap, etc. Remove these stains with tar remover or turpentine. Rinse it off immediately so it does not harm the finish. Remember to re-wax these areas, even if the rest of the vehicle does not need waxing.
- When you have washed and rinsed the whole exterior, dry it with a chamois or soft towel. Letting it air-dry will cause dulling and water spots.

As you dry the vehicle, inspect it for chips and scratches that could allow corrosion to start. Repair them with touch-up paint (see page 290).





Exterior Care

Roof Antenna

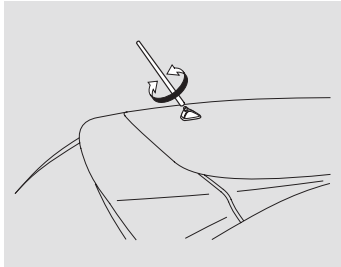

Your vehicle is equipped with a roof antenna on the rear centre of the roof. If you use a “drive-through” car wash, make sure you remove the antenna first by turning it by hand. This prevents the antenna from being damaged by the car wash brushes.

Afterward, reinstall the antenna and tighten it securely by hand.

Waxing

Always wash and dry the whole vehicle before waxing it. You should wax your vehicle, including the metal trim, whenever water sits on the surface in large patches. It should form into beads or droplets after waxing.

You should use a quality liquid or paste wax. Apply it according to the instructions on the container. In general, there are two types of products:

Waxes — A wax coats the finish and protects it from damage by exposure to sunlight, air pollution, etc. You should use a wax on your vehicle when it is new.

Polishes — Polishes and cleaner/waxes can restore the shine to paint that has oxidized and lost some of its shine. They normally contain mild abrasives and solvents that remove the top layer of the finish. You should use a polish on your vehicle if the finish does not have its original shine after using a wax.

Cleaning tar, insects, etc. with removers also takes off the wax. Remember to re-wax those areas, even if the rest of the vehicle does not need waxing.





Exterior Care

Aluminium Wheels (For some types)

Clean your vehicle's aluminium alloy wheels as you do the rest of the exterior. Wash them with the same solution, and rinse them thoroughly.

The wheels have a protective clearcoat that keeps the aluminium from corroding and tarnishing. Using harsh chemicals, including some commercial wheel cleaners or stiff brushes, can damage this clear-coat. Only use a mild detergent and soft brush or sponge to clean the wheels.

Paint Touch-up

Your dealer has touch-up paint to match your vehicle's colour. The colour code is printed on a plate attached to the left damper housing in the engine compartment. Take this code to your dealer so you are sure to get the correct colour.

Inspect your vehicle frequently for chips or scratches in the paint. Repair them right away to prevent corrosion of the metal underneath. Use the touch-up paint only on small chips and scratches. More extensive paint damage should be repaired by a professional.





Interior Care

Carpeting

Vacuum the carpeting frequently to remove dirt. Ground-in dirt will make the carpet wear out faster. Periodically shampoo the carpet to keep it looking new. Use one of the foam-type carpet cleaners on the market. Follow the instructions that come with the cleaner, applying it with a sponge or soft brush. Keep the carpeting as dry as possible by not adding water to the foam.

Floor Mats

If equipped

The driver's floor mat that came with your vehicle hooks over the floor mat anchors. This keeps the floor mat from sliding forward and possibly interfering with the pedals.

If you remove the driver's floor mat, make sure to re-anchor it when you put it back in your vehicle.

If you use non-Honda floor mats, make sure they fit properly and that they can be used with the floor mat anchors. Do not put additional floor mats on top of an anchored mat.

Fabric

Vacuum dirt and dust out of the material frequently. For general cleaning, use a solution of mild soap and lukewarm water, letting it air dry. To clean off stubborn spots, use a commercially-available fabric cleaner. Test it on a hidden area of the fabric first, to make sure it does not bleach or stain the fabric. Follow the instructions that come with the cleaner.

Vinyl

Remove dirt and dust with a vacuum cleaner. Wipe the vinyl with a soft cloth dampened in a solution of mild soap and water. Use the same solution with a soft-bristle brush on more difficult spots. You can also use commercially-available spray or foam-type vinyl cleaners.





Interior Care

Leather (For some types)

Vacuum dirt and dust from the leather frequently. Pay particular attention to the pleats and seams. Clean the leather with a soft cloth dampened with clear water, then buff it with a clean, dry cloth. If further cleaning is needed, use a soap specifically for leather, such as saddle soap. Apply this soap with a damp, soft cloth. Wipe down and buff as described above.

If you use a leather cleaner, wipe it off quickly with a soft and dry cloth. Never leave a cloth soaked with leather cleaner on any part of the interior. If left for a long time, some leather cleaners may cause discoloration or cracking of interior trim or fabric.

Windows

Clean the windows, inside and out, with a commercially-available glass cleaner. You can also use a mixture of one part white vinegar to ten parts water. This will remove the haze that builds up on the inside of the windows. Use a soft cloth or paper towels to clean all glass and clear plastic surfaces.

NOTICE

The rear window demister wire is bonded to the inside of the glass. Wiping vigorously up-and-down can dislodge and break these wires. When cleaning the rear window, use gentle pressure and wipe side-to-side.

Seat Belts

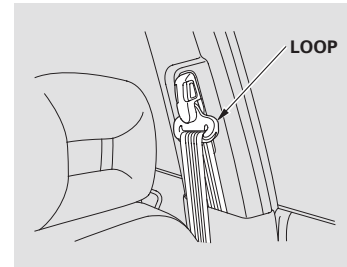

Clean dirty seat belts with a soft brush and a mixture of mild soap and warm water. Do not use bleach, dye, or cleaning solvents. They can weaken the belt material. Let the belts air dry before you use the vehicle.

292 Appearance Care





Interior Care

Dirt build-up in the loops of the seat belt anchors can cause the belts to retract slowly. Wipe the insides of the loops with a clean cloth dampened in mild soap and warm water or isopropyl alcohol.

Air Fresheners

If you want to use an air freshener/deodorizer in the interior of your vehicle, it is best to use a solid type. Some liquid air fresheners contain chemicals that may cause parts of the interior trim and fabric to crack or discolour.

If you use a liquid air freshener, make sure you fasten it securely so it does not spill as you drive.

Dust and Pollen Filter (For some types)

This filter removes the dust and pollen that is brought in from the outside through the climate control system.

This filter should be replaced during scheduled maintenance. See the maintenance schedules in this owner's manual.

On EU models, refer to the maintenance schedule in the Service Book that came with your vehicle.

On New Zealand model, refer to the maintenance schedule in the Service Maintenance and Warranty Book that came with your vehicle.

The dust and pollen filter should be replaced at short intervals if you drive primarily in urban areas that have high concentrations of soot in the air from industry and diesel-powered vehicles. Replace it more often if airflow from the heating and cooling system becomes less than usual.





Corrosion Protection

Two factors normally contribute to causing corrosion in your vehicle:

1. Moisture trapped in body cavities. Dirt and road salt that collects in hollows on the underside of the vehicle stays damp, promoting corrosion in that area.
2. Removal of paint and protective coatings from the exterior and underside of the vehicle.

Many corrosion-preventive measures are built into your vehicle. You can help keep your vehicle from corroding by performing some simple periodic maintenance:

- Repair chips and scratches in the paint as soon as you discover them.
- Inspect and clean out the drain holes in the bottom of the doors and body.
- Check the floor coverings for dampness. Carpeting and floor mats may remain damp for a long time, especially in winter. This dampness can eventually cause the floor panels to corrode.
- Use a high-pressure spray to clean the underside of your vehicle. This is especially important in areas that use road salt in winter. It is also a good idea in humid climates and areas subject to salty air. Vehicles equipped with ABS have a sensor and wiring at each wheel. Be careful not to damage them.
- Have the corrosion-preventive coatings on the underside of your vehicle inspected and repaired periodically.





Taking Care of the Unexpected

This section covers the more common problems that motorists experience with their vehicles. It gives you information about how to safely evaluate the problem and what to do to correct it. If the problem has stranded you on the side of the road, you may be able to get going again. If not, you will also find instructions on getting your vehicle towed.

Compact Spare Tyre.....	296
Changing a Flat Tyre	297
If the Engine Won't Start.....	303
Jump Starting	305
If the Engine Overheats	
Petrol models	308
Diesel models.....	310
Low Oil Pressure Indicator	
(Red)	312
Oil Level Indicator (Amber).....	313
Charging System Indicator.....	314
Malfunction Indicator Lamp	
Petrol models	314
Diesel models.....	315
Glow Plugs Indicator	316
Brake System Indicator	317
Fuses	318
Fuse Locations	
Petrol models	321
Diesel models.....	323
Emergency Towing	325





Compact Spare Tyre

Use the compact spare tyre as a temporary replacement only. Get your regular tyre repaired or replaced, and put it back on your vehicle as soon as you can.

Check the compact spare tyre inflation pressure every time you check the other tyres. It should be inflated to:
420 kPa (4.2 kgf/cm² , 60 psi)

Follow these precautions:

- Never exceed 80 km/h (50 mph).
- This tyre gives a harsher ride and less traction on some road surfaces. Use greater caution while driving.
- Do not mount snow chains on the compact spare tyre.

- Do not use your compact spare tyre on another vehicle unless it is the same make and model.
- Do not use more than one compact spare tyre at the same time.
- Do not use the compact spare tyre if you are towing a trailer.

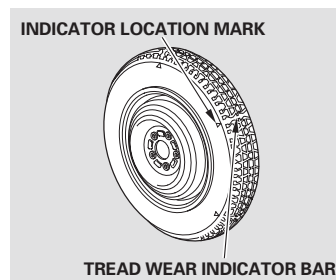

The compact spare tyre has a shorter tread life than a regular tyre. Replace the tyre when you can see the tread wear indicator bars. The replacement should be the same size and design tyre, mounted on the same wheel. The spare tyre is not designed to be mounted on a regular wheel, and the spare wheel is not designed for mounting a regular tyre.



296 Taking Care of the Unexpected





Changing a Flat Tyre

If you have a flat tyre while driving, stop in a safe place to change it. Stopping in traffic or on the shoulder of a busy road is dangerous. Drive slowly along the shoulder until you get to an exit or an area to stop that is far away from the traffic lanes.

NOTICE

Use the jack that came with your vehicle. If you try to raise another vehicle with this jack or use another jack to raise your vehicle, the vehicle or jack can be damaged.

⚠ WARNING

The vehicle can easily roll off the jack, seriously injuring anyone underneath.

Follow the directions for changing a tyre exactly, and never get under the vehicle when it is supported only by the jack.

1. Park the vehicle on firm, level and non-slippery ground. Put the transmission in Park (automatic) or reverse (manual). Apply the parking brake.

If you are towing a trailer, unhitch the trailer.

2. Turn on the hazard warning indicators, and turn the ignition switch to the LOCK (0) position. Have all the passengers get out of the vehicle while you change the tyre.

CONTINUED

Taking Care of the Unexpected 297





Changing a Flat Tyre

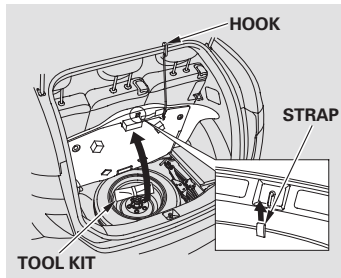

3. Open the tailgate. Raise the luggage area floor by lifting up on the strap.
To keep the luggage area floor out of the way, attach the hook to the tailgate sill.
4. Take the tool kit out of the spare tyre well.

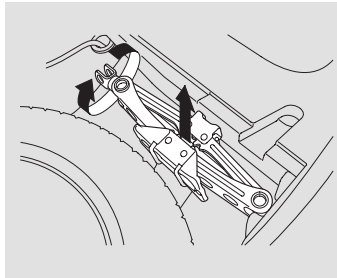

5. Take the jack out of the luggage area.

Turn the jack's end bracket anticlockwise to loosen it, then remove the jack.

6. Unscrew the wing bolt and take the spare tyre out of its well.
7. Place blocks in front and back of the wheel diagonally opposite the tyre you are changing.



298 Taking Care of the Unexpected





Changing a Flat Tyre

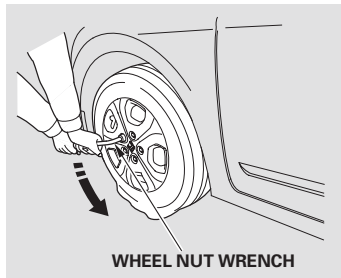

8. Loosen the four wheel nuts 1/2 turn with the wheel nut wrench.

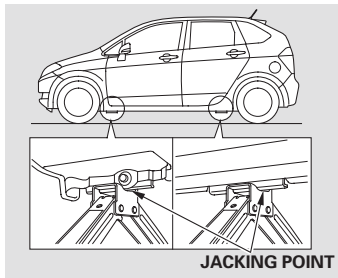

9. Place the jack under the jacking point nearest the tyre you need to change. Turn the end bracket clockwise until the top of the jack contacts the jacking point. Make sure the jacking point tab is resting in the jack notch.

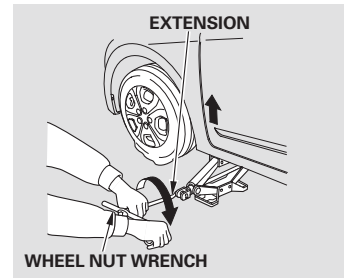

10. Use the extension and the wheel nut wrench as shown to raise the vehicle until the flat tyre is off the ground.

CONTINUED

Taking Care of the Unexpected 299





Changing a Flat Tyre

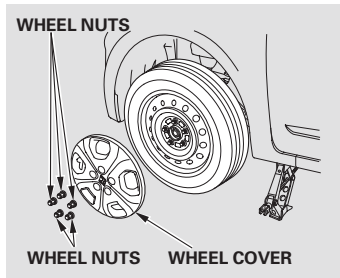

11. Remove the wheel nuts and wheel cover (on some types). Handle the wheel nuts carefully; they may be hot from driving. The wheel cover cannot be removed without first removing the wheel nuts. Do not attempt to forcibly pry the wheel cover off with a screwdriver or other tool.

12. Remove the flat tyre. Place the flat tyre on the ground with the outside surface facing up. You could scratch the wheel if you put it face down.

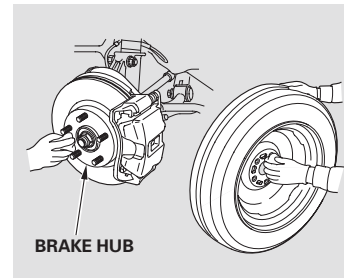

13. Before mounting the spare tyre, wipe any dirt off the mounting surface of the wheel and hub with a clean cloth. Wipe the hub carefully; it may be hot from driving.

300 Taking Care of the Unexpected





Changing a Flat Tyre

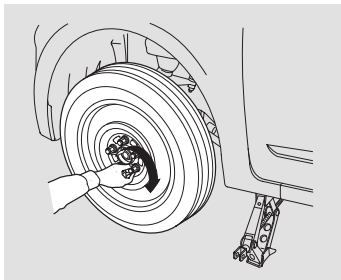

14. Put on the spare tyre. Put the wheel nuts back on finger-tight, then tighten them in a crisscross pattern with the wheel nut wrench until the wheel is firmly against the hub. Do not try to tighten the wheel nuts fully.

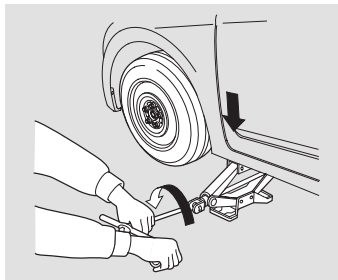

15. Lower the vehicle to the ground, and remove the jack.

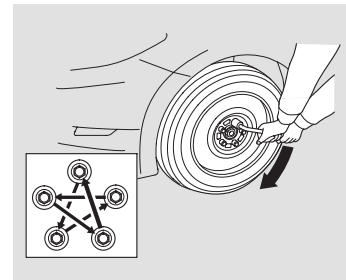

16. Tighten the wheel nuts securely in the same crisscross pattern. Have the wheel nut torque checked at the nearest automotive service facility.

Tighten the wheel nuts to:
108 N·m (11 kgf·m , 80 lbf·ft)

CONTINUED

Taking Care of the Unexpected 301





Changing a Flat Tyre

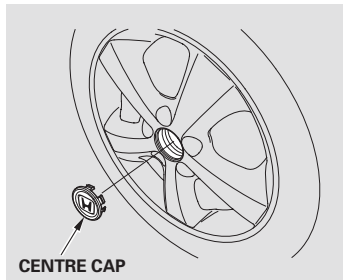

17. On some types, remove the centre cap before storing the flat tyre in the spare tyre well.

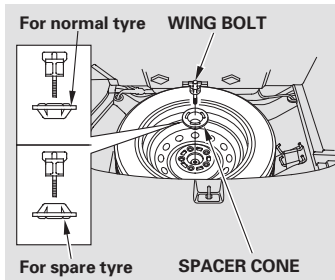

18. Adjust the rear centre seat forward as far as it will possibly go.
19. Place the flat tyre face down in the spare tyre well.
20. Remove the spacer cone from the wing bolt, turn it over, and put it back on the bolt.
21. Secure the flat tyre by screwing the wing bolt back into its hole.

22. Store the jack in its holder. Turn the jack's end bracket clockwise to lock it in place. Store the tool kit. Replace the cover.

⚠ WARNING

Loose items can fly around the interior in a crash and could seriously injure the occupants.

Store the wheel, jack, and tools securely before driving.

Store the wheel cover or centre cap in the luggage area. Make sure it will not get scratched or damaged.

23. Close the tailgate.

302 Taking Care of the Unexpected





If the Engine Won't Start

Diagnosing why the engine won't start falls into two areas, depending on what you hear when you turn the ignition switch to the START (III) position:

- You hear nothing, or almost nothing. The engine's starter motor does not operate at all, or operates very slowly.
- You can hear the starter motor operating normally, or the starter motor sounds like it is spinning faster than normal, but the engine does not start up and run.

Nothing Happens or the Starter Motor Operates Very Slowly

When you turn the ignition switch to the START (III) position, you do not hear the normal noise of the engine trying to start. You may hear a clicking sound, a series of clicks, or nothing at all.

Check these things:

- Check the transmission interlock. On some manual transmission models, the clutch pedal must be pushed all the way to the floor or the starter will not operate. With an automatic transmission, it must be in Park or neutral.
- Turn the ignition switch to the ON (II) position. Turn on the headlights, and check their brightness. If the headlights are very dim or do not come on at all, the battery is discharged. See **Jump Starting** on page 305 .

- Turn the ignition switch to the START (III) position. If the headlights do not dim, check the condition of the fuses. If the fuses are OK, there is probably something wrong with the electrical circuit for the ignition switch or starter motor. You will need a qualified technician to determine the problem. See **Emergency Towing** on page 325 .

If the headlights dim noticeably or go out when you try to start the engine, either the battery is discharged or the connections are corroded. Check the condition of the battery and terminal connections (see page 318). You can then try jump starting the vehicle from a booster battery (see page 305).





If the Engine Won't Start

The Starter Operates Normally

In this case, the starter motor's speed sounds normal, or even faster than normal, when you turn the ignition switch to the START (III) position, but the engine does not run.

- Are you using the proper starting procedure? Refer to **Starting the Engine** on page 202 on petrol models and page 203 on diesel models.
- Are you using a properly coded key? An improperly coded key will cause the immobilizer system indicator in the instrument panel to blink rapidly (see page 97).
- Do you have fuel? Check the fuel gauge; the low fuel indicator may not be working.

- There may be an electrical problem, such as no power to the fuel pump. Check all the fuses (see page 318).
- On vehicles with a fuel cutoff system, the fuel cutoff switch may be activated. If the switch is activated, it must be reset before starting the engine (see page 191).

On diesel models

- If your vehicle runs out of fuel, priming the fuel system is required to restart the engine (see page 284).

On diesel models

- After you have stored your vehicle for an extended period, air may have entered the fuel system (see **Priming the Fuel System** on page 284).

On diesel models

- After you parked the vehicle for an extended period or when the outside temperature becomes very high, water stays in the fuel system and the engine will not start. In this case, you should drain the water from the fuel filter (see page 255).

If you find nothing wrong, you will need a qualified technician to find the problem. See **Emergency Towing** on page 325.



304 Taking Care of the Unexpected





Jump Starting

Although this seems like a simple procedure, you should take several precautions.

⚠ WARNING

A battery can explode if you do not follow the correct procedure, seriously injuring anyone nearby.

Keep all sparks, open flames, and smoking materials away from the battery.

You cannot start your vehicle with an automatic transmission by pushing or pulling it.

To Jump Start Your Vehicle:

1. Open the bonnet, and check the physical condition of the battery. In very cold weather, check the condition of the electrolyte. If it seems slushy or frozen, do not try jump starting until it thaws.

NOTICE

If a battery sits in extreme cold, the electrolyte inside can freeze. Attempting to jump start with a frozen battery can cause it to rupture.

2. Turn off all the electrical accessories: heater, A/C, stereo system, lights, etc. Put the transmission in neutral (manual) or Park (automatic), and set the parking brake.

CONTINUED

Taking Care of the Unexpected 305





Jump Starting

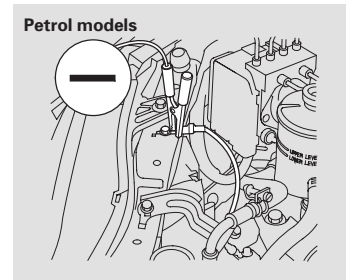
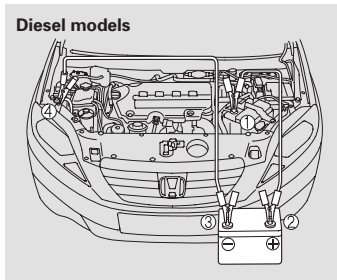
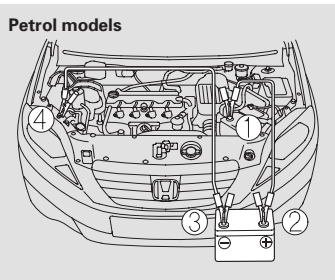

The numbers in the illustrations show you the order to connect the jumper cables.

3. Connect one jumper cable to the positive (+) terminal on your battery. Connect the other end to the positive (+) terminal on the booster battery.

4. Connect the second jumper cable to the negative (-) terminal on the booster battery. Connect the other end to the grounding strap as shown. Do not connect this jumper cable to any other part of the engine.

306 Taking Care of the Unexpected





Jump Starting

Diesel models

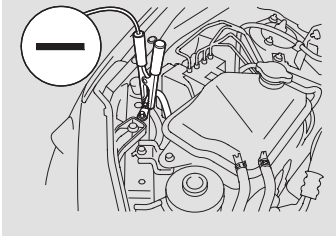

5. If the booster battery is in another vehicle, have an assistant start that vehicle and run it at a fast idle.
6. Start the vehicle. If the starter motor still operates slowly, check that the jumper cables have good metal-to-metal contact.

7. Once the vehicle is running, disconnect the negative cable from your vehicle, then from the booster battery. Disconnect the positive cable from your vehicle, and then from the booster battery.

Keep the ends of the jumper cables away from each other and any metal on the vehicle until everything is disconnected. Otherwise, you may cause an electrical short.





If the Engine Overheats (Petrol models)

The pointer of the vehicle's temperature gauge should stay in the midrange. If it climbs to the red mark, you should determine the reason (hot day, driving up a steep hill, etc.).

If your vehicle overheats, you should take immediate action. The only indication may be the temperature gauge climbing to or above the red mark. Or you may see steam or spray coming from under the bonnet.

NOTICE

Driving with the temperature gauge pointer at the red mark can cause serious damage to your engine.

▲ WARNING

Steam and spray from an overheated engine can seriously scald you.

Do not open the bonnet if steam is coming out.

1. Safely pull to the side of the road. Put the transmission in neutral (manual) or Park (automatic), and set the parking brake. Turn off all accessories, and turn on the hazard warning indicators.
2. If you see steam and/or spray coming from under the bonnet, turn off the engine. Wait until you see no more signs of steam or spray, then open the bonnet.
3. If you do not see steam or spray, leave the engine running and watch the temperature gauge. If the high heat is due to overloading, the engine should start to cool down almost immediately. If it does, wait until the temperature gauge comes down to the midpoint, then continue driving.
4. If the temperature gauge stays at the red mark, turn off the engine.
5. Look for any obvious coolant leaks, such as a split radiator hose. Everything is still extremely hot, so use caution. If you find a leak, it must be repaired before you continue driving (see **Emergency Towing** on page 325).





If the Engine Overheats (Petrol models)

6. If you do not find an obvious leak, check the coolant level in the radiator reserve tank. Add coolant if the level is below the MIN mark.
7. If there was no coolant in the reserve tank, you may need to add coolant to the radiator. Let the engine cool down until the pointer reaches the middle of the temperature gauge, or lower, before checking the radiator.



⚠ WARNING

Removing the radiator cap while the engine is hot can cause the coolant to spray out, seriously scalding you.

Always let the engine and radiator cool down before removing the radiator cap.

8. Using gloves or a large heavy cloth, turn the radiator cap anticlockwise, without pushing down, to the first stop. After the pressure releases, push down on the cap, and turn it until it comes off.
9. Start the engine, and set the temperature control to maximum. Add coolant to the radiator up to the base of the filler neck. If you do not have the proper coolant mixture available, you can add plain water. Remember to have the cooling system drained and refilled with the proper mixture as soon as you can.
10. Put the radiator cap back on tightly. Run the engine, and check the temperature gauge. If it goes back to the red mark, the engine needs repair (see **Emergency Towing** on page 325).
11. If the temperature stays normal, check the coolant level in the radiator reserve tank. If it has gone down, add coolant to the MAX mark. Put the cap back on tightly.





If Your Engine Overheats (Diesel models)

The pointer of the vehicle's temperature gauge should stay in the midrange. If it climbs to the red mark, you should determine the reason (hot day, driving up a steep hill, etc.).

If your vehicle overheats, you should take immediate action. The only indication may be the temperature gauge climbing to or above the red mark. Or you may see steam or spray coming from under the bonnet.

NOTICE

Driving with the temperature gauge pointer at the red mark can cause serious damage to your engine.

⚠ WARNING

Steam and spray from an overheated engine can seriously scald you.

Do not open the bonnet if steam is coming out.

1. Safely pull to the side of the road. Put the transmission in neutral, and set the parking brake. Turn off the all accessories, and turn on the hazard warning indicators.
2. If you see steam and/or spray coming from under the bonnet, turn off the engine. Wait until you see no more signs of steam or spray, then open the bonnet.
3. If you do not see steam or spray, leave the engine running and watch the temperature gauge. If the high heat is due to overloading, the engine should start to cool down almost immediately. If it does, wait until the temperature gauge comes down to the midpoint, then continue driving.
4. If the temperature gauge stays at the red mark, turn off the engine.



310 Taking Care of the Unexpected





If Your Engine Overheats (Diesel models)

5. Look for any obvious coolant leaks, such as a split radiator hose. Everything is still extremely hot, so use caution. If you find a leak, it must be repaired before you continue driving (see **Emergency Towing** on page 325).
6. If you don't find an obvious leak, check the coolant level in the expansion tank (see page 190).
7. If the expansion tank needs coolant, you will have to add coolant. Before doing that, turn the ignition switch to the ON (II) position and check the temperature gauge. Remove the expansion tank cap only if the temperature gauge pointer has come down to normal or below the red mark and you do not hear any bubbling or gurgling noise coming from the cooling system.

⚠ WARNING

Removing the expansion tank cap while the engine is hot can cause the coolant to spray out, seriously scalding you.

Always let the engine and radiator cool down before removing the expansion tank cap.

8. Use gloves or a large heavy cloth while removing the expansion tank cap. Loosen the cap by turning it 1/8 turn anticlockwise. Stop and wait for any pressure in the expansion tank to escape. Then remove the cap by turning it anticlockwise.

9. Start the engine and set the temperature control to maximum. Add coolant up to the MAX line on the expansion tank. If you do not have the proper coolant mixture available, you can add plain water. Remember to have the cooling system drained and refilled with the proper mixture as soon as you can.
10. Put the expansion tank cap back on tightly. Run the engine, and check the temperature gauge. If it goes back to the red mark, the engine needs repair (see **Emergency Towing** on page 325).
11. If the temperature stays normal, check the coolant level in the expansion tank. If it has gone down, add coolant to the MAX mark. Put the expansion tank cap back on tightly.

Taking Care of the Unexpected **311**





Low Oil Pressure Indicator (Red)



This indicator should come on briefly in amber, then red when the ignition switch is in the ON (II) position, and go out after the engine starts.

It should never come on red when the engine is running. If it turns on red and starts flashing or stays on, the oil pressure has dropped very low or lost pressure. Serious engine damage is possible and you should take immediate action.

NOTICE

Running the engine with low oil pressure can cause serious mechanical damage almost immediately. Turn off the engine as soon as you can safely get the vehicle stopped.

1. Safely pull off the road, and shut off the engine. Turn on the hazard warning indicators.

2. Let the vehicle sit for a minute. Open the bonnet, and check the oil level (see page 188). An engine very low on oil can lose pressure during cornering and other driving manoeuvres.

3. If necessary, add oil to bring the level back to the full mark on the dipstick (see page 239 on petrol models, and page 241 on diesel models).

4. Start the engine, and watch the oil pressure indicator. If it does not go out within 10 seconds, turn off the engine. There is a mechanical problem that needs to be repaired before you can continue driving (see **Emergency Towing** on page 325).

The same design indicator may come on amber while you are driving. This indicates that the engine oil level becomes low and reminds you to check the engine oil level (see page 188). If it blinks in amber while you are driving, there is a system problem in the engine oil level sensor.



312 Taking Care of the Unexpected





Oil Level Indicator (Amber)



This indicator should come on briefly in amber, then red when the ignition switch is in the ON (II) position, and go out after the engine starts.

If this indicator comes on amber when the engine is running, the engine oil level is low. Safely pull off the road, park the vehicle on level ground, turn off the engine and let the vehicle sit for approximately 3 minutes.

Check the oil level (see page 188). If the engine oil level is near or below the lower mark on the dipstick, you should add the engine oil (see page 239 on petrol models, and page 241 on diesel models).

Do not fill above the upper mark on the dipstick and do not spill the engine oil in the engine compartment. This could damage the engine and other components.

If you do not carry spare engine oil in your vehicle, drive moderately to the nearest service area and add engine oil. Avoid full-throttle acceleration and driving at high speed.

The oil level indicator can be reset each time you turn off the engine. When you start your trip again, the system begins to monitor the engine oil level. It may take a while until the system senses the engine oil level is low and the indicator comes on amber. You should check the engine oil level and add engine oil before driving again if the oil level indicator comes on.

NOTICE

If you ignore the oil level indicator and keep driving with this indicator on, you can seriously damage the engine.

If the amber indicator blinks while driving, there is a system problem in the engine oil level sensor. Have your dealer inspect your vehicle as soon as possible.

This system activates after the engine warms up. If the outside temperature is extremely low, you may have to drive for a long time until the system senses the engine oil level.





Charging System Indicator, Malfunction Indicator Lamp (Petrol models)



Charging System Indicator

This indicator should come on when the ignition switch is in the ON (II) position, and go out after the engine starts. If the charging system indicator comes on brightly when the engine is running, the battery is not being charged.

Immediately turn off all electrical accessories. Try not to use other electrically operated controls such as the power windows. Keep the engine running; starting the engine will discharge the battery rapidly.

Go to a dealer or a service station where you can get technical assistance.



Malfunction Indicator Lamp (Petrol models)

This indicator comes on, then goes out when you turn the ignition switch to the ON (II) position. If the indicator comes on while driving, it means one of the engine's emissions control systems may have a problem. Even though you may feel no difference in your vehicle's performance, it can reduce your fuel economy and cause increased emissions. Continued operation may cause serious damage.

If this indicator comes on, safely pull off the road and turn off the engine. Restart the engine and watch the indicator. If it stays on, have your vehicle checked by the dealer as soon as possible. Drive moderately until the dealer has inspected the problem. Avoid full-throttle acceleration and driving at high speed.

You should also have the dealer inspect your vehicle if the indicator comes on frequently, even though it goes off when you follow the above procedure.

NOTICE

If you keep driving with the malfunction indicator lamp on, you can damage your vehicle's emissions controls and engine. Those repairs may not be covered by your vehicle's warranties.

If you turn the ignition switch to the ON (II) position, without starting the engine, the malfunction indicator lamp will come on for about 20 seconds. It then goes off or blinks 5 times under various conditions. This is normal: it shows the self-testing condition of the diagnostics for the emissions control systems.

314 Taking Care of the Unexpected





Malfunction Indicator Lamp (Diesel models)



This indicator comes on, then goes out when you turn the ignition switch to the ON (II) position. If it comes on at any other time, it indicates one of the emissions control systems may have a problem. Even though you may feel no difference in your vehicle's performance, it can reduce your fuel economy and cause your vehicle to put out excessive emissions. Continued operation may cause serious damage.

If this indicator comes on, safely pull off the road and turn off the engine. Restart and turn off the engine at least three times at intervals of approximately 30 seconds, then watch the indicator. If it stays on, have your vehicle checked by your dealer as soon as possible. Drive moderately until the dealer has inspected the problem. Avoid full-throttle acceleration and driving at high speed.

You should also have the dealer inspect your vehicle if the indicator comes on frequently, even though it goes off when you follow the above procedure.

NOTICE

If you keep driving with the malfunction indicator lamp on, you can damage your vehicle's emissions controls and engine. Those repairs may not be covered by your vehicle's warranties.

The indicator may come on along with the glow plugs indicator if the emissions control systems have several problems.

This indicator will also come on and you cannot restart the engine after your vehicle has run out of fuel. If this occurs, refuel the fuel tank, then follow the procedure for **Priming the Fuel System** on page 284 before attempting to restart the engine.

If you turn the ignition switch to the ON (II) position, without starting the engine, the malfunction indicator lamp will come on for about 20 seconds. It then goes off or blinks 5 times under various conditions. This is normal: it shows the self-testing condition of the diagnostics for the emissions control systems.





Glow Plugs Indicator (Diesel models)



This indicator comes on for a few seconds (several seconds in cold weather or at high altitudes) when you turn the ignition switch to the ON (II) position. If it blinks while the engine is running, there is a problem in the engine control system. Continued operation may cause serious damage.

If this indicator blinks, safely pull off the road and turn off the engine. Restart and turn off the engine at least three times at intervals of approximately 30 seconds, then watch the indicator. If it starts to blink again, have your vehicle checked by your dealer as soon as possible. Drive moderately until the dealer has inspected the problem. Avoid full-throttle acceleration and driving at high speed.

You should also have the dealer inspect your vehicle if the indicator blinks frequently, even though it goes off when you follow the above procedure.

NOTICE

If you keep driving with the glow plugs indicator blinking, you can damage your vehicle's emissions controls and engine. Those repairs may not be covered by your vehicle's warranties.

This indicator may blink along with malfunction indicator lamp if the emissions control systems have several problems.

This indicator will also blink and you cannot restart the engine after your vehicle has run out of fuel. If this occurs, refuel the fuel tank, then follow the procedure for **Priming the Fuel System** on page 284 before attempting to restart the engine.

This indicator may also blink if you do not use the proper fuel for the climate or regional condition. This may cause the engine power to reduce (see page 184).

316 Taking Care of the Unexpected





Brake System Indicator

 The brake system indicator normally comes on when you turn the ignition switch to the ON (II) position, and as a reminder to check the parking brake. It will stay on if you do not fully release the parking brake.

If the brake system indicator comes on while driving, the brake fluid level is probably low. Press lightly on the brake pedal to see if it feels normal. If it does, check the brake fluid level the next time you stop at a service station (see page 250).

If the fluid level is low, take your vehicle to a dealer, and have the brake system inspected for leaks or worn brake pads.

However, if the brake pedal does not feel normal, you should take immediate action. A problem in one part of the system's dual circuit design will still give you braking at two wheels. You will feel the brake pedal go down much farther before the vehicle begins to slow down, and you will have to press harder on the pedal.

Slow down by shifting to a lower gear, and pull to the side of the road when it is safe. Because of the long distance needed to stop, it is hazardous to drive the vehicle. You should have it towed and repaired as soon as possible (see **Emergency Towing** on page 325).

If you must drive the vehicle a short distance in this condition, drive slowly and carefully.

If the ABS indicator comes on with the brake system indicator, have your vehicle inspected by your dealer immediately.





Fuses

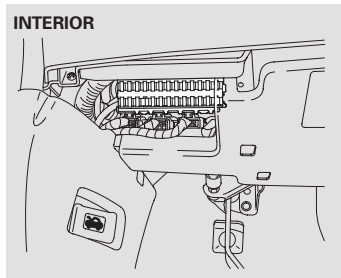

The vehicle's fuses are contained in two fuse boxes.

The interior fuse box is under the dashboard on the driver's side.

The under-bonnet fuse box is located on the left or right side of the engine compartment. To open it, push the tabs as shown.

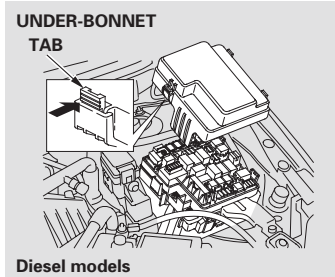
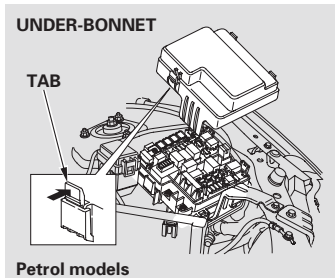

Checking and Replacing Fuses

If something electrical in your vehicle stops working, the first thing you should check for is a blown fuse. Determine from the chart on pages 321 and 322 on petrol models, and pages 323 and 324 on diesel models, or the diagram on the fuse box lid, which fuse or fuses control that device. Check those fuses first, but check all the fuses before deciding that a blown fuse is the cause. Replace any blown fuses, and check if the device works.

318 Taking Care of the Unexpected





Fuses

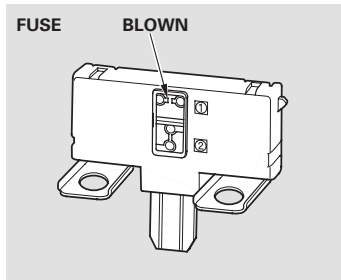

1. Turn the ignition switch to the LOCK (0) position. Make sure the headlights and all other accessories are off.
2. Remove the cover from the fuse box.

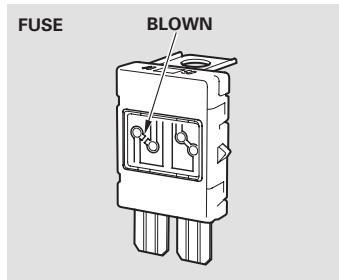

3. Check each of the large fuses in the under-bonnet fuse box by looking through the side window at the wire inside. Remove the screws with a Phillips-head screwdriver.

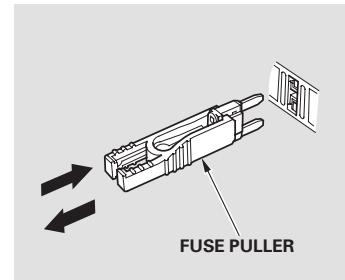

4. Check the smaller fuses in the under-bonnet fuse box and all the fuses in the interior fuse box by pulling out each one with the fuse puller provided in the under-bonnet fuse box.

CONTINUED

Taking Care of the Unexpected 319





Fuses

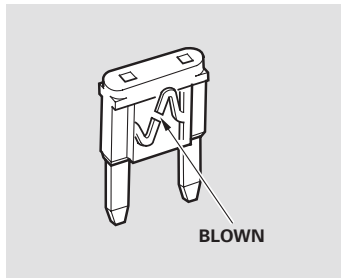

5. Look for a burned wire inside the fuse. If it is burned out, replace it with one of the spare fuses of the same rating or lower.

If you cannot drive the vehicle without fixing the problem, and you do not have a spare fuse, take a fuse of the same rating or a lower rating from one of the other circuits with the fuse puller provided in the under-bonnet fuse box. Make sure you can do without that circuit temporarily (such as the cigarette lighter or radio).

If you replace the blown fuse with a spare fuse that has a lower rating, it might blow out again. This does not indicate anything wrong. Replace the fuse with one of the correct rating as soon as you can.

NOTICE

Replacing a fuse with one that has a higher rating greatly increases the chances of damaging the electrical system. If you do not have a replacement fuse with the proper rating for the circuit, install one with a lower rating.

6. If the replacement fuse of the same rating blows in a short time, there is probably a serious electrical problem with your vehicle. Leave the blown fuse in that circuit, and have your vehicle checked by a qualified technician.

320 Taking Care of the Unexpected





Fuse Locations (Petrol models)

UNDER-BONNET FUSE BOX

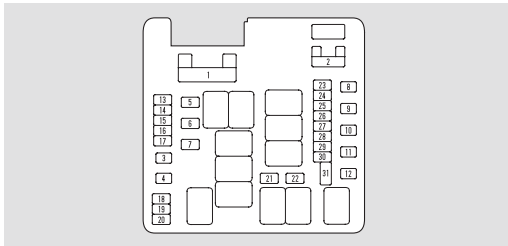

The fuses contained in the under-bonnet fuse box vary slightly depending on models. On some models, the locations of fuses are shown with symbols on the fuse label. Refer to the table below for the fuses on your vehicle.

FUSE BOX LABEL (On some types)

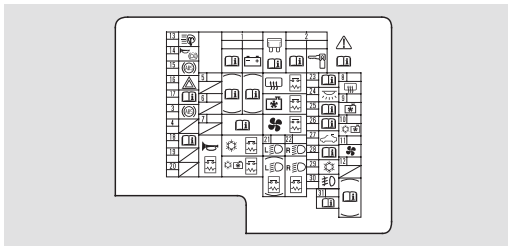

No.	Circuits Protected	No.	Circuits Protected
1	Battery	15	LAF Sensor
	Not Used	16	Hazard
2	Ignition Switch	17	Daytime Running Light*
	Option	18	Not Used
3	ABS P	19	Oil Level Sensor
	VSA P	20	Stop Switch
4	ABS V	21	Left Headlight
	VSA V	22	Right Headlight
5	Headlight Washer*	23	Back Up
6	Not Used	24	Interior Light
7	Not Used	25	Not Used
8	Rear Demister	26	Super Lock*
9	Radiator Fan	27	Sunroof*
10	Condenser Fan	28	Front Demister
11	Heater Motor	29	MG Clutch
12	Not Used	30	Front Fog Lights*
13	Ignition Coil	31	FR Wiper AS
14	Horn, Stop		

* : For some types

Taking Care of the Unexpected **321**





Fuse Locations (Diesel models)

UNDER-BONNET FUSE BOX

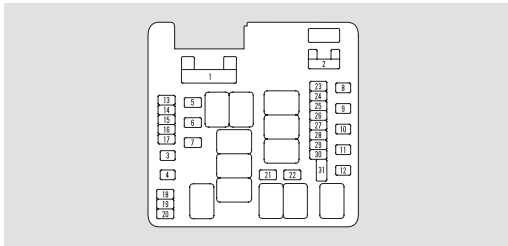

The fuses contained in the under-bonnet fuse box vary slightly depending on models. On some models, the locations of fuses are shown with symbols on the fuse label. Refer to the table below for the fuses on your vehicle.

FUSE BOX LABEL

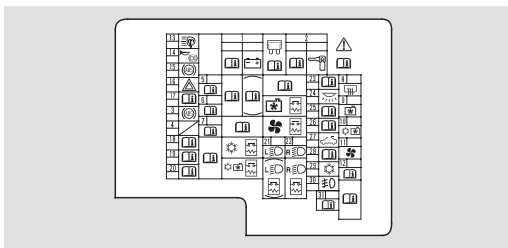

No.	Circuits Protected	No.	Circuits Protected
1	Battery	15	Sunroof*
	Glow Plug	16	Hazard
2	Ignition Switch	17	Daytime Running Light*
	Option	18	Fuel Heater Monitor
3	ABS P	19	Fuel Heater
	VSA P	20	Stop Switch
4	ABS V	21	Left Headlight
	VSA V	22	Right Headlight
5	PTC HTR1	23	Back Up
6	PTC HTR2	24	Interior Light
7	PTC HTR3	25	PGM-FI (ECM) Main
8	Rear Demister	26	Super Lock*
9	Radiator Fan	27	Intake Shutter Valve
10	Condenser Fan	28	PGM-FI (ECM) Sub
11	Heater Motor	29	MG Clutch
12	Fuel Heater	30	Front Fog Lights*
13	Headlight Washer*	31	FR Wiper AS
14	Horn, Stop		

* : For some types

Taking Care of the Unexpected **323**





Fuse Locations (Diesel models)

INTERIOR FUSE BOX

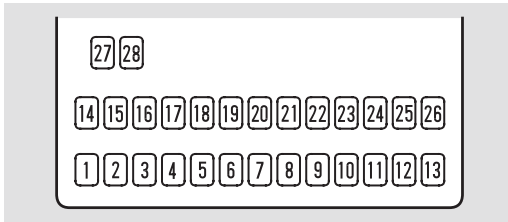

The fuses contained in the interior fuse box vary slightly depending on models. The locations of fuses are shown with symbols on the fuse label. Refer to the table below for the fuses on your vehicle.

No.	Circuits Protected
1	Back Light
2	SRS
3	ABS
4	Not Used
5	Front Wiper
6	Not Used
7	PGM-FI (ECM)
8	ACG
9	Meter
10	Heated Seat*
11	Rear Fog Light
12	IGP
13	Not Used
14	Rear Wiper
15	SRS
16	Mirror

No.	Circuits Protected
17	Lighting*
18	IG HAC
19	Passenger's Power Window
20	Left Rear Power Window
21	Right Rear Power Window
22	Door Locks
23	Driver's Power Window
24	Audio
25	Heated Mirror
26	Small Light
27	ACC Cigarette Lighter
28	ACC

FUSE BOX LABEL

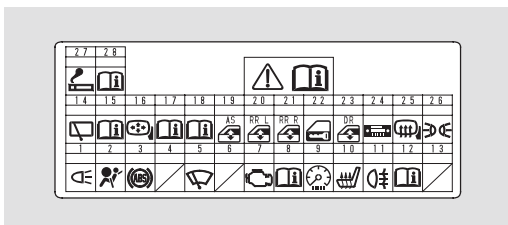

* : For some types

324 Taking Care of the Unexpected





Emergency Towing

If your vehicle needs to be towed, call a professional towing service or an organization. Never tow your vehicle with just a rope or chain. It is very dangerous.

There are three popular types of professional towing equipment.

Flat-bed Equipment – The operator loads your vehicle on the back of a truck. **This is the best way to transport your vehicle.**

Wheel-lift Equipment – The tow truck uses two pivoting arms that go under the front tyres and lift them off the ground. The other two rear tyres remain on the ground. **This is an acceptable way to tow your vehicle.**

Sling-type Equipment – The tow truck uses metal cables with hooks on the ends. These hooks go around parts of the frame or suspension and the cables lift that end of the vehicle off the ground. Your vehicle's suspension and body can be seriously damaged. **This method of towing is unacceptable.**

If, due to damage, your vehicle must be towed with the front wheels on the ground, do this:

On vehicles with manual transmission

- Release the parking brake.
- Shift the transmission to neutral.

On vehicles with automatic transmission

- Release the parking brake.
- Start the engine.
- Shift to D, then to N.
- Turn off the engine.
- Leave the ignition switch in the ACCESSORY (I) position so the steering wheel does not lock.

NOTICE

Improper towing preparation will damage the transmission. Follow the above procedure exactly. If you cannot shift the transmission or start the engine, your vehicle must be transported with the front wheels off the ground.

With the front wheels on the ground, it is best to tow the vehicle no farther than 80 km (50 miles), and keep the speed below 55 km/h (35 mph).

If your vehicle is equipped with a front spoiler, remove it before towing so it is not damaged.

CONTINUED

Taking Care of the Unexpected **325**





Emergency Towing

NOTICE

Trying to lift or tow your vehicle by the bumpers will cause serious damage. The bumpers are not designed to support the vehicle's weight.

NOTICE

The steering system can be damaged if the steering wheel is locked. Leave the ignition switch in the ACCESSORY (I) position, and make sure the steering wheel turns freely before you begin towing.





Technical Information

The diagrams in this section give you the dimensions and capacities of your vehicle, and the locations of the identification numbers.

Identification Numbers.....	328
Specifications	330
Three Way Catalytic Converter...	336
Catalytic Converters.....	337
Diesel Particulate Filter (DPF) System.....	338





Identification Numbers

Your vehicle has several identifying numbers located in various places.

1. The chassis number is stamped on the fire wall.
2. The engine number is stamped into the engine block.
3. The transmission number is on a label on top of the transmission.

Do not mistake the transmission number for the engine number.



Petrol models

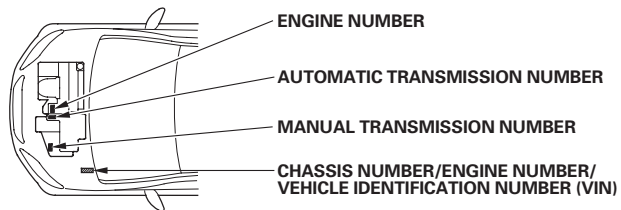

Diesel models

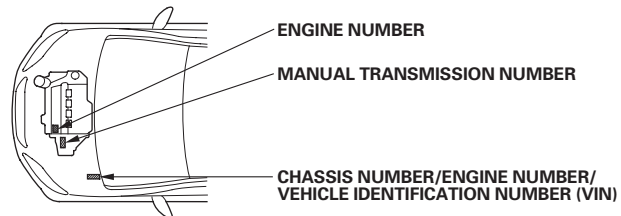



Identification Numbers

On some types, the chassis number/ chassis and engine numbers also appear on the plate attached to the left damper housing.

On some other types, a certification plate is attached to the driver's doorjamb.

The Vehicle Identification Number (VIN) appears on a plate attached to the engine compartment bulkhead or the left damper housing, and on a plate fastened to the top of the dashboard on some types.

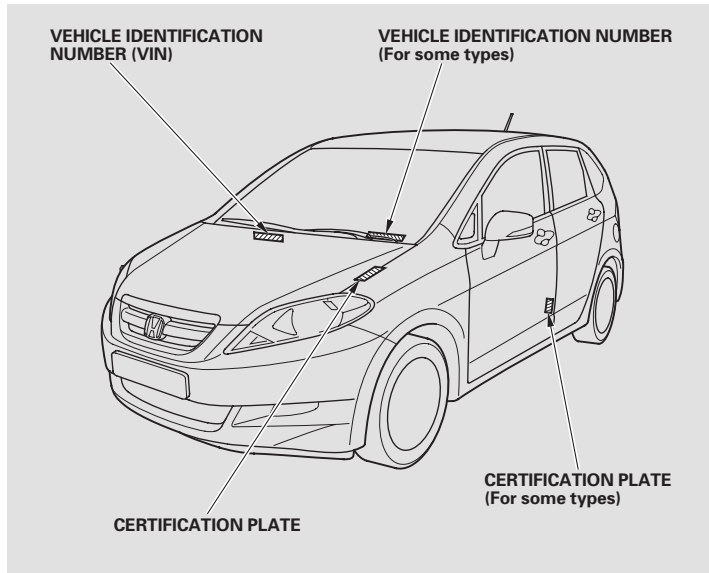



Specifications

Dimensions		
Length		4,285 mm (168.7 in)
Width		1,810 mm (71.3 in)
		1,795 mm (70.7 in) ^{*1}
Height		1,610 mm (63.4 in) ^{*2}
		1,625 mm (64.0 in) ^{*3}
Wheelbase		2,685 mm (105.7 in)
Track	Front	1,555 mm (61.2 in)
	Rear	1,575 mm (62.0 in)

- * 1 : Bermuda models
- * 2 : Without roof rail
- * 3 : With roof rail

The mounting point/rear overhang of coupling device

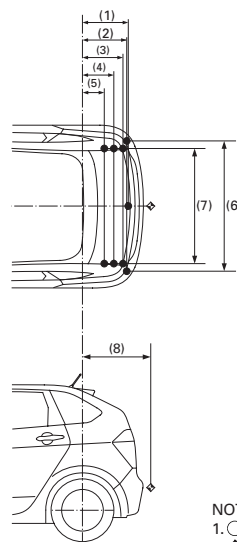

No.	Dimensions
(1)	556 mm (21.9 in)
(2)	555 mm (21.9 in)
(3)	528 mm (20.8 in)
(4)	391 mm (15.4 in)
(5)	295 mm (11.6 in)
(6)	1,148 mm (45.2 in)
(7)	1,035 mm (40.7 in)
(8)	854 mm (33.6 in)

- NOTE:
1. ○ marks show towbar fixing points.
 2. ◆ mark shows towbar coupling point.

330 Technical Information





Specifications

Weights			
Curb weight		1,423–1,483 kg (3,137–3,269 lbs) ^{*1}	
		1,449–1,510 kg (3,194–3,329 lbs) ^{*2}	
		1,573–1,632 kg (3,468–3,598 lbs) ^{*3}	
Max. permissible weight		1,975 kg (4,354 lbs) ^{*1}	
		2,020 kg (4,453 lbs) ^{*2}	
		2,130 kg (4,696 lbs) ^{*3}	
Max. permissible axle weight	Front	1,010 kg (2,227 lbs) ^{*1}	
		1,030 kg (2,271 lbs) ^{*2}	
		1,145 kg (2,524 lbs) ^{*3}	
	Rear	990 kg (2,183 lbs) ^{*1}	
		1,000 kg (2,205 lbs) ^{*2}	
		985 kg (2,172 lbs) ^{*3}	
Max. towing weight (EU) ^{*1,*2}		Trailer with brakes	1,500 kg (3,307 lbs)
		Trailer without brakes	500 kg (1,102 lbs)
The maximum permissible vertical load on the coupling device			90 kg (198 lbs)

* 1 : Petrol models (MT)
 * 2 : Petrol models (AT)
 * 3 : Diesel models

* 1 : The following is for Germany only.
 The maximum trailer weight is valid for 12 % slope. For an increasing of the trailer weight you have to look in your vehicle paper or ask your next dealer.
 * 2 : The maximum towing weight should be reduced if you tow a trailer over 1,000 meters of elevation. For more information, see page 222 .



CONTINUED

Technical Information **331**





Specifications

Engine (Petrol models)

Type	Water cooled 4-stroke SOHC VTEC in line, 4-cylinder gasoline engine
Bore x Stroke	81 x 87.3 mm (3.19 x 3.44 in)
Displacement	1,799 cm ³ (110 cu-in)
Compression ratio	10.5 : 1
Spark Plugs	NGK: IZFR6K-11S DENSO: SKJ20DR-M11S

Engine (Diesel models)

Type	Water cooled 4-stroke DOHC TURBO in line, 4-cylinder diesel engine
Bore x Stroke	85.0 x 97.1 mm (3.35 x 3.82 in)
Displacement	2,204 cm ³ (134 cu-in)
Compression ratio	16.7 : 1



332 Technical Information





Specifications

Capacities

Fuel tank		Approx. 58 ℓ (15.3 US gal , 12.8 Imp gal)
Engine coolant (Petrol models)		
Right-hand drive type		
Change* ¹	AT	4.9 ℓ (1.29 US gal , 1.08 Imp gal)
	MT	4.9 ℓ (1.29 US gal , 1.08 Imp gal)
Total	AT	6.1 ℓ (1.61 US gal , 1.34 Imp gal)
	MT	6.2 ℓ (1.64 US gal , 1.36 Imp gal)
Left-hand drive type		
Change* ¹	AT	4.8 ℓ (1.27 US gal , 1.06 Imp gal)
	MT	4.9 ℓ (1.29 US gal , 1.08 Imp gal)
Total	AT	6.1 ℓ (1.61 US gal , 1.34 Imp gal)
	MT	6.2 ℓ (1.64 US gal , 1.36 Imp gal)
Engine coolant (Diesel models)		
Change* ²		6.3 ℓ (1.66 US gal , 1.39 Imp gal)* ³ 6.8 ℓ (1.80 US gal , 1.50 Imp gal)* ⁴
Total		8.0 ℓ (2.11 US gal , 1.76 Imp gal)

Engine Oil (Petrol models)		
Change* ⁵		
Including filter		3.7 ℓ (3.9 US qt , 3.3 Imp qt)
Without filter		3.5 ℓ (3.7 US qt , 3.1 Imp qt)
Total		4.5 ℓ (4.8 US qt , 4.0 Imp qt)
Engine Oil (Diesel models)		
Change* ⁵		
Including filter		5.9 ℓ (6.2 US qt , 5.2 Imp qt)
Without filter		5.5 ℓ (5.8 US qt , 4.8 Imp qt)
Total		6.5 ℓ (6.9 US qt , 5.7 Imp qt)

* 5 : Excluding the oil remaining in the engine

- * 1 : Including the coolant in the reserve tank and that remaining in the engine.
Reserve tank capacity: 0.6 ℓ (0.16 US gal , 0.13 Imp gal)
Heater capacity: 0.55 ℓ (0.145 US gal , 0.121 Imp gal)
- * 2 : Including the coolant in the heater and the expansion tank and that remaining in the engine.
Expansion tank capacity: 0.8 ℓ (0.21 US gal , 0.18 Imp gal)
Heater capacity: 0.7 ℓ (0.18 US gal , 0.15 Imp gal)
- * 3 : Without removing the drain bolt on the engine
- * 4 : With removing the drain bolt on the engine

CONTINUED

Technical Information **333**





Specifications

Capacities

Manual transmission fluid	Change	2.1 ℓ (2.2 US qt, 1.8 Imp qt) ^{*1}
		2.2 ℓ (2.3 US qt, 1.9 Imp qt) ^{*2}
	Total	2.3 ℓ (2.4 US qt, 2.0 Imp qt) ^{*1}
		2.5 ℓ (2.6 US qt, 2.2 Imp qt) ^{*2}
Automatic transmission fluid	Change	2.6 ℓ (2.7 US qt, 2.3 Imp qt)
		7.0 ℓ (7.4 US qt, 6.2 Imp qt)
	Total	4.5 ℓ (4.8 US qt, 4.0 Imp qt) ^{*3}
Windscreen washer reservoir		5.8 ℓ (6.1 US qt, 5.1 Imp qt) ^{*4}

- * 1 : Petrol models
- * 2 : Diesel models
- * 3 : Without headlight washer
- * 4 : With headlight washer

Tyres

Size/Pressure	See tyre information label on driver's doorjamb or ask dealer for information.
---------------	--

Alignment

Toe-in	Front	0.0 mm (0.00 in)
	Rear	in 2.0 mm (0.08 in)
Camber	Front	0°
	Rear	-1°
Caster	Front	3°47'



334 Technical Information





Specifications

Suspension

Type	Front	Strut
	Rear	Double wishbone

Steering

Type	Rack and pinion, with hydraulic power assistance
------	--

Clutch

Type	Dry, single plate, diaphragm spring
------	-------------------------------------

Brake

Type	Power assisted
Front	Ventilated disc
Rear	Solid disc
Parking	Mechanical

Battery

Capacity	Petrol models	12 V — 45 AH/20 HR
	Diesel models	12 V — 74 AH/20 HR

Fuses

Interior	See page 322 on petrol models and page 324 on diesel models, or the fuse label attached to the inside of the fuse box door under the steering column.
Under-bonnet	See page 321 on petrol models and page 323 on diesel models, or the fuse box cover.

Lights

Headlights	High	12 V — 60 W (H4)
	Low	12 V — 55 W (HB2)
	High/Low	12 V — 35 W * ¹
Front turn signal lights		12 V — 21 W (Amber)
Front position lights		12 V — 5 W
Rear turn signal lights		12 V — 21 W (Amber)
Stop/tail-lights		12 V — 21/5 W
Back-up lights		12 V — 21 W
Rear fog light* ²		12 V — 21 W
Licence plate lights		12 V — 5 W
High-mount brake light		12 V — 18 W
Spotlights		12 V — 8 W
Ceiling lights	Front	12 V — 8 W
	Rear	12 V — 8 W
Front fog lights* ²		12 V — 55 W

* 1 : On vehicles with high voltage discharge type headlights, replacement of a headlight bulb should be performed by your dealer.

* 2 : For some types





Three Way Catalytic Converter (Petrol models)

The three way catalytic converter contains precious metals that serve as catalysts, promoting chemical reactions to convert the exhaust gasses without affecting the metals. The catalytic converter is referred to as a three-way catalyst, since it acts on HC, CO, and NOx. A replacement unit must be an original Honda part or its equivalent.

The three way catalytic converter must operate at a high temperature for the chemical reactions to take place. It can set on fire any combustible materials that come near it. Park your vehicle away from high grass, dry leaves, or other flammables.

A defective three way catalytic converter contributes to air pollution, and can impair your engine's performance. Follow these guidelines to protect your vehicle's three way catalytic converter.

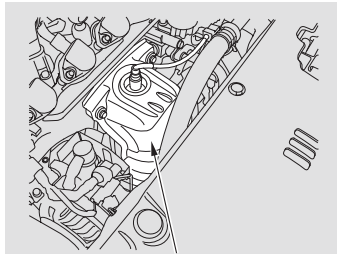

THREE WAY CATALYTIC CONVERTER

- Keep the engine well maintained.
- Have your vehicle diagnosed and repaired if it is misfiring, backfiring, stalling, or otherwise not running properly.

- Always use unleaded petrol. Even a small amount of leaded petrol can contaminate the catalyst metals, making the three way catalytic converter ineffective.

336 Technical Information





Catalytic Converters (Diesel models)

The catalytic converter contains precious metals that serve as catalysts, promoting chemical reactions to convert the exhaust gasses without affecting the metals. The catalytic converters are equipped with your vehicle to reduce HC, CO, NOx, and PM. A replacement unit must be an original Honda part or its equivalent.

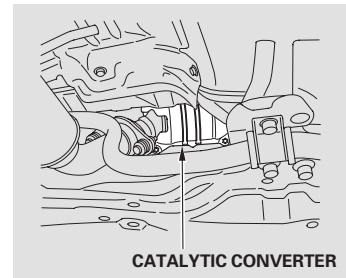
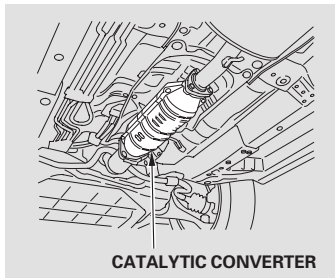

- Always use only diesel fuel recommended in this owner's manual (see page 184).





Catalytic Converters (Diesel models)

Diesel Particulate Filter (DPF) System (For some types)

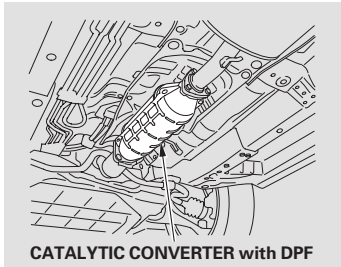

Your vehicle is equipped with the diesel particulate filter (DPF) system to remove the particulate matter (PM) from the exhaust gas in normal high speed driving. The DPF is installed in the catalytic converter.

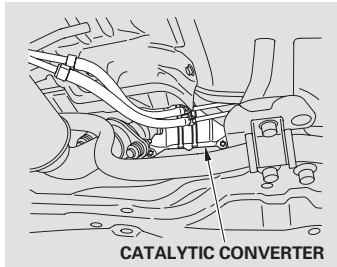

The PM will be burnt out and removed from the DPF at a periodically high temperature of the catalytic converter. While the PM is burnt, you may notice some white smoke in the exhaust gas.

The DPF system requires no regular maintenance. If you drive for long periods at slow speeds, particulate matter (PM) will be accumulated and the regeneration of DPF will be required. The condition of the accumulated PM will vary with the type of diesel fuel. Always use the recommended diesel fuel in this owner's manual (see page 184).





Catalytic Converters (Diesel models)



Diesel Particulate Filter (DPF) Indicator

If this indicator blinks while the engine is running, the diesel particulate filter (DPF) should be regenerated to remove the accumulated particulate matter (PM).

To regenerate the DPF, when traffic allows, maintain a vehicle speed of at least 60 km/h (37 mph) and continue to drive until the indicator goes out (it may take about 15 minutes). This will increase the exhaust temperature and help to burn and remove the PM from the DPF.

If you ignore the indicator blinking, it stops blinking, then stays on. If this happens, take your vehicle to a Honda dealer as soon as possible to have the DPF system checked. If you ignore this indicator and continue driving, the DPF and your vehicle's emission control systems will be seriously damaged.

The catalytic converter and DPF system must operate at a high temperature for the chemical reactions to take place. It can set on fire any combustible materials that come near it. Park your vehicle away from high grass, dry leaves, or other flammables.





06/10/30 17:28:26 32SJD620_343



340





Index

A		
Accessories and Modifications	193	Average Fuel Mileage
ACCESSORY (Ignition Key		Audio System
Position)	98	Automatic Seat Belt Tensioners
Accessory Power Socket	135	Automatic Speed Control.....
Adding Engine Coolant.....	243, 246	Automatic Transmission.....
Additives, Engine Oil	240, 242	Capacity, Fluid
Airbag (SRS)	12, 26	Checking Fluid Level
Air Cleaner Element.....	253	D3 Mode
Air Conditioning System.....	140	Position Indicators.....
Maintenance.....	270	Shifting.....
Usage	146, 147	Shift Lock Release.....
Air Outlets(Vents)	140	Automatic Wipers.....
Air Pressure, Tyres	274	Auxiliary Input Jack.....
Aluminium Wheels, Cleaning	290	
Antifreeze	243, 246	B
Anti-lock Brakes (ABS)		Battery
Indicator.....	76, 215	Charging System
Operation.....	215	Indicator.....
Anti-theft Steering Column		Jump Starting
Lock.....	98	Maintenance.....
Appearance Care	287	Specifications
Aquaplaning.....	220	Before Driving
Armrest.....	111	Belts, Seat
Ashtray.....	135	Beverage Holders
		Bonnet, Opening the
		Booster Seat
		Brakes
		Anti-lock System (ABS).....
		Break-in, New Linings
		Bulb Replacement
		Fluid
		Parking.....
		System Indicator
		Wear Indicators
		Braking System.....
		Break-in, New Vehicle
		Brightness Control,
		Instruments
		Brights, Headlights

CONTINUED





Index

Bulb Replacement	CD Player.....	Tethers.....
Back-up Lights..... 263	CD Player Error Messages 172	Where Should a Child Sit?..... 33
Brake Lights..... 263	Ceiling Lights..... 136	Childproof Door Locks 101
Front Fog Lights..... 266	Centre Pocket 133	Cigarette Lighter 134
Front Position Lights 262	Certification Plate 329	Cleaner Element, Air..... 253
Headlights 258	Chains, Tyres 279	Cleaning
High-mount Brake Light 264	Changing a Flat Tyre 297	Aluminium Wheels..... 290
Interior Lights..... 268	Changing Oil	Carpeting 291
Licence Plate Lights..... 265	When to..... 229	Exterior 288
Rear Fog Light..... 263	Charging System Indicator ... 74, 314	Fabric 291
Rear Lights..... 263	Chassis Number 328	Interior 291
Specifications 335	Checklist, Before Driving..... 201	Leather..... 292
Spotlights..... 268	Child Restraint Systems 43	Seat Belts..... 292
Turn Signal Lights..... 260, 263	Lower Anchorages 47	Vinyl 291
Bulbs, Halogen..... 258, 266	Tether Anchor Points 57	Windows 292
	Child Restraint Systems for EU..... 46	Climate Control System..... 140
C	Child Safety 32	Clock 174
Capacities Chart 333, 334	Booster Seats 61	Clutch Fluid 250
Carbon Monoxide Hazard 65	Child Restraint Systems 43	Coat Hooks..... 134
Carrying Luggage..... 195	Important Safety	Cold Weather, Starting in..... 202, 203
Catalytic Converters..... 337	Reminders 32	Compact Spare Tyre..... 296
CAUTION, Explanation of ii	Infants 39	Controls, Instruments and..... 69
CD Care 171	Larger Children 60	
CD Changer..... 166	Lower Anchorages 47	
CD Changer Error Messages 173	Risks with Airbags..... 33, 36	
	Small Children..... 41	





Index

Coolant			
Adding.....	243, 246		
Checking.....	189		
Proper Solution	243, 246		
Temperature Gauge	82		
Corrosion Protection	294		
Cruise Control Indicator	77		
Cruise Control Operation	179		
Cup Holders.....	132		
Cushion Tray.....	131		
D			
DANGER, Explanation of.....	ii		
Dashboard	2, 4, 70, 71		
Daytime Running Lights.....	90		
Dead Battery	305		
Defrosting the Windows.....	146		
Demister, Rear Window	94		
Detachable Anchor.....	117		
Diesel Engine	332		
Diesel Fuel.....	184		
Diesel Particulate Filter(DPF).....	338		
Indicator	80		
Dimensions	330		
Dimming the Headlights	90		
Dipstick			
Automatic Transmission.....	249		
Engine Oil.....	188		
Directional Signals.....	90		
Disc Brake Wear Indicators.....	214		
Disc Player.....	161		
Doors			
Locking and Unlocking.....	99		
Power Door Locks.....	99		
Super Locking	100		
Downshifting			
Automatic Transmission.....	207		
Manual Transmission	204		
Draining Water	80		
Driver and Passenger Safety.....	7		
Driver's Pocket	132		
Driving	199		
Economy	192		
Guidelines.....	200		
In Bad Weather.....	219		
Dust and Pollen Filter	293		
D3 Mode	209		
E			
Economy, Fuel	192		
Emergencies.....	295		
Battery, Jump Starting	305		
Brake System Indicator	317		
Changing a Flat Tyre	297		
Charging System Indicator	314		
Checking the Fuses.....	318		
Glow Plugs Indicator.....	316		
Hazard Warning Flashers	94		
Jump Starting	305		
Low Oil Pressure Indicator	312		
Malfunction Indicator			
Lamp	314, 315		
Oil Level Indicator	313		
Overheated Engine	308, 310		
Towing	325		
Emergency Brake.....	128, 129		
Emergency Flashers	94		
Emergency Towing	325		

CONTINUED





Index

Engine	Filters	Economy	192
Coolant Temperature Gauge	Air Cleaner	Fill Door and Cap	185
Glow plugs Indicator	Dust and Pollen	Filter	255
If It Won't Start	Fuel	Gauge	83
Malfunction Indicator	Flashers, Hazard Warning	Mileage	84
Lamp	Flat Tyre, Changing a	Low Fuel Indicator	79
Oil Level Indicator	Floor Mats	Octane Requirement	184
Oil Pressure Indicator	Fluids	Tank, Refueling	185
Oil, What Kind to Use	Automatic Transmission	Fuses, Checking the	318
Overheating	Brake		
Specifications	Clutch	G	
Starting	Manual Transmission	Gauges	
Engine Coolant	Power Steering	Engine Coolant Temperature	82
Engine Number	Windscreen Washers	Fuel	83
Exhaust Fumes	Folding Door Mirrors	Speedometer	81
Expansion Tank	Folding Rear Seat	Tachometer	81
Expectant Mothers,	Four-way Flashers	Gearshift Lever Positions	
Use of Seat Belts by	Front Airbags	Automatic Transmission	207
Exterior, Cleaning the	Front Fog Lights	Manual Transmission	204
	Front Seat	Glass Cleaning	292
F	Adjusting	Glove Box	131
Fabric, Cleaning	Airbags	Glow Plugs Indicator	79, 316
Fan, Interior	Heaters		
Features	Fuel		
Filling the Fuel Tank	Cutoff System		
	Diesel		



**Index**

H	I	
Halogen Headlight Bulbs.....	Identification Number, Vehicle....	Rear Fog Light
258	328	77
Hazard Warning Flashers.....	Ignition	Seat Belt Reminder.....
94	Keys.....	75
Headlights	Switch.....	Security System
Adjuster	96	78
122	Immobilizer System.....	SRS
Aiming	97	30, 75
258	Important Safety Precautions	Turn Signal and Hazard
Daytime Running Lights.....	8	Warning
90	Indicators	77
High Beam Indicator	74	VSA Activation
76	ABS (Anti-lock Brake)	78
Lights On Indicator	76	VSA System
76	Brake (Parking and Brake	78
Low Beams, Turning on	System)	80
90	75, 317	Water In Diesel Filter
Reminder Chime.....	Charging System	80
90	74, 314	Indicators, Instrument Panel.....
Replacing Halogen Bulbs	Cruise Control.....	74
258	77	Infant Restraint
Turning on.....	Diesel Particulate Filter (DPF) ..	39
90	80	Infant Seats.....
Washer.....	77	Lower Anchorages
87	Door-open	47
Head Restraints	77	Tether Anchor Points
110	Front Fog Light	57
Heated Mirror	77	Inflation, Proper Tyre
127	Glow Plugs.....	274
Heater, Seat.....	79, 316	Inside Mirror
119	High Beam.....	126
Heating and Air Conditioning	76	Inspection, Tyre
System.....	Key (Immobilizer System)	275
140	76	Instrument Panel
High Altitude, Starting at	Lights On	72, 73
202, 203	76	Instrument Panel Brightness
High-Low Beam Switch	Low Fuel	93
90	79	Interior Cleaning.....
High-mount Brake Light.....	Low Oil Pressure	291
264	74, 312	Interior Lights.....
Horn	Malfunction Indicator	136
3, 5, 85, 86	Lamp.....	Introduction
Hydraulic Clutch.....	74, 314, 315	i
252	Oil Level (Amber)	
	74, 313	

CONTINUED





Index

J

Jacking up the Vehicle 299
 Jack, Tyre 298
 Jump Starting 305

K

Keys..... 96

L

Label, Certification 329
 Lane Change, Signaling 90
 Lap/Shoulder Belts 17, 21
 Lights
 Bulb Replacement 256
 Indicators 74
 Position 90
 Turn Signal 90
 Load Limit 196
 LOCK (Ignition Key Position) 98
 Lockable Retractor 52, 53, 55
 Locks
 Anti-theft Steering Column 98
 Fuel Fill Door 185

Glove Box 131
 Power Door 99
 Super Locking 100
 Tailgate 102
 Low Coolant Level 189
 Low Fuel Indicator 79
 Low Oil Pressure Indicator 74, 312
 Lower Anchorages 47
 Lower Gear, Downshifting
 to a 204

Lubricant Specifications
 Chart 333-334
 Luggage, How to Carry 195
 Luggage Hooks 198
 Luggage, Storing 195

M

Maintenance 227
 Owner's Maintenance
 Checks 230
 Record 236
 Safety 228
 Schedule 229-235
 Malfunction Indicator
 Lamp 74, 314, 315

Manual Transmission..... 204
 Manual Transmission Fluid 249
 Maximum Allowable Shift
 Speeds..... 205, 210
 Meters, Gauges..... 72, 81
 Mirrors, Adjusting 126
 Modifying Your Vehicle..... 194

N

New Vehicle Break-in 184
 Normal Shift Speeds..... 205
 NOTICE, Explanation of..... i
 Numbers, Identification 328

O

Octane Requirement,
 Petrol..... 184
 Odometer 83
 Odometer, Trip 83



**Index**

Oil	Filter	255	Using Lower Anchorages.....	47
Change, When to	Fuel Cutoff System.....	191		
Checking Engine	Fuel Economy	192	R	
Level Indicator (Amber).....	Fuel Mileage.....	84	Radiator Overheating.....	308, 310
Pressure Indicator	Gauge	83	Radio/CD Sound System.....	148
Selecting Proper Viscosity	Low Fuel Indicator	79	Range	84
Chart	Octane Requirement	184	RDS.....	153
.....	Refueling.....	185	Rear Fog Light	91
Oil Level Indicator (Amber)...	Polishing and Waxing	289	Rear Lights, Bulb	
ON (Ignition Key Position)	Pollen Filter	293	Replacement.....	263
Outside Mirrors	Position Lights	90	Rear Seat, Armrest	111
Outside Temperature Indicator	Power Door Locks.....	99	Rear Seat, Folding	115
Overheating, Engine	Power Steering Fluid.....	252	Rear View Mirror.....	126
Owner's Maintenance Checks	Power Windows	123	Rear Window Demister	94
	Pregnancy, Using Seat Belts	19	Rear Windscreen Wiper and	
P	Priming the Fuel System	284	Washer.....	89
Paint Touch-up.....	Proper Seat Belt Usage	17	Reclining the Front Seats	113
Panel Brightness Control	Protecting Adults and Teens.....	14	Recommended Shift	
Parking	Additional Safety Precautions.....	20	Speeds	205
Parking Brake	Advice for Pregnant Women.....	19	Reminder Indicators.....	74
Parking Brake and Brake	Protecting Children	32	Remote Audio Controls.....	176
System Indicator.....	Protecting Infants.....	39	Remote Transmitter	104
Parking Over Things That	Protecting Larger Children	60		
Burn.....	Protecting Small Children	41		
Petrol.....	Using Child Restraint Systems			
Filling the Fuel Tank.....	with Tethers.....	57		

CONTINUED





Index

Replacement Information	Seat Belts	10, 21	Sound System.....	148
Air Cleaner Element.....	Additional Information.....	21	Spare Tyre	
Dust and Pollen Filter	Automatic Seat Belt		Compact.....	296
Fuel Filter	Tensioners.....	23	Inflating.....	296
Fuses	Cleaning	292	Specifications	334
Light Bulbs.....	Detachable Anchor.....	117	Spark Plug	332
Schedule	Lap/Shoulder Belt.....	17, 21	Specifications Charts.....	330
Tyres	Maintenance.....	23	Speedometer	81
Wiper Blades.....	Reminder Indicator and		Speed-sensitive Volume	
Replacing Seat Belts After a	Beeper.....	21, 75	Compensation (SVC)	159
Crash	System Components.....	21	Spotlights	137
Reserve Tank, Engine	Use During Pregnancy.....	19	SRS, Additional Information.....	26
Coolant.....	Seat Heaters	119	Additional Safety Precautions....	31
189, 243, 246	Seat Under Box.....	133	How the SRS Indicator	
Restraint, Child	Seats, Adjusting the.....	108	Works.....	30
Reverse Lockout.....	Security System	177	How Your Front Airbags	
Roof Rack	Service Intervals	229	Work.....	27
Rotation, Tyre	Service Station Procedures	185	How Your Side Airbags Work....	28
	Setting the Clock	174	How Your Side Curtain Airbags	
S	Side Airbags	12, 28	Work.....	29
Safety Belts.....	How Your Side Airbags Work....	28	SRS Components	26
Safety Features	Risks to Children	36	SRS Service.....	30
Airbags.....	Side Curtain Airbags	12, 29	SRS Indicator.....	30, 75
Seat Belts.....	Signaling Turns.....	90	START (Ignition Key Position)	98
Safety Labels, Location of	Snow Tyres.....	278		
Safety Messages	Solvent-type Cleaners.....	288		





Index

Starting the Engine 202, 203	Tailgate 102	Fluid Selection..... 249
Cold Climates 203	Tail-lights, Changing Bulbs	Identification Number..... 328
In Cold Weather at High	in 263	Shifting the Automatic..... 207
Altitude 202	Taking Care of the Unexpected .. 295	Shifting the Manual..... 204
Switching Off 203	Technical Descriptions	Treadwear 275
Warming Up..... 203	Catalytic Converters..... 337	Trip Meter 83
With a Dead Battery 305	Three Way Catalytic	Turn Signals 90
Steam Coming from	Converter..... 336	Tyre Chains 279
Engine 308, 310	Temperature Gauge 82	Tyre, How to Change a Flat 297
Steering Wheel	Temperature, Inside Sensor..... 147	Tyres 274
Adjustment 95	Temperature, Outside..... 82	Air Pressure 274
Anti-theft Column Lock 98	Tether Anchor Points..... 57	Balancing 276
Stereo Sound System 148	Three Way Catalytic Converter... 336	Chains 279
Storing Your Vehicle 283	Tilt the Steering Wheel..... 95	Checking Wear 275
Sunroof..... 125	Time, Setting the 174	Compact Spare 296
Operation 125	Tonneau Cover..... 120	Inflation 274
Super Locking 100	Tools, Tyre Changing 298	Inspection 275
Supplemental Restraint	Towing	Maintenance..... 276
System..... 12, 26	A Trailer..... 221	Replacing 277
Servicing 30	Emergency Wrecker..... 325	Rotating..... 276
SRS Indicator..... 30, 75	Equipment and Accessories..... 223	Snow 278
System Components..... 26	Weight Limit 221	Specifications 334
	Trailer Hitch Mounting Points..... 330	
T	Trailer Loading 221	
Tachometer 81	Trailer Towing Tips..... 225	
	Transmission	

CONTINUED





Index

U	
Ultrasonic Sensor	178
Underside, Cleaning	294
Unexpected, Taking Care of the	295
Upholstery Cleaning.....	291

V	
Vanity Mirror	134
Vehicle Capacity Load	196
Vehicle Dimensions.....	330
Vehicle Identification Number.....	329
Vehicle Stability Assist (VSA) System.....	217
Activation Indicator	78, 217
System Indicator	78, 217
On/Off Switch	218
Vehicle Storage.....	283
Ventilation	140
VIN	329
Vinyl Cleaning	291
Viscosity, Oil	239, 241

W	
WARNING, Explanation of	ii
Warning Labels, Location of	66
Washer, Windscreen Checking the Fluid Level	248
Operation	87
Washing	288
Water Draining	255
Indicator.....	80
Water In Diesel Filter Indicator.....	80
Waxing and Polishing	289
Wheels Adjusting the Steering	95
Alignment and Balance.....	276
Cleaning Aluminium Alloys.....	290
Compact Spare.....	296
Nut Wrench.....	299
Windows Auto Reverse.....	124
Cleaning	292
Operating the Power	123
Rear, Demister.....	94
Windscreen Cleaning	87, 292
Washers	87

Wipers	87
Winter Tyres	278
Wiper Blades Changing.....	271
Operation	87
Rear Windscreen Wiper and Washer	89
Worn Tyres	275
Wrecker, Emergency Towing.....	325

